

KINTEK

DOUBLE CONTACT TOOLHOLDERS DK
MANDRINI DOPPIO CONTATTO DK



**DOUBLE CONTACT
TOOLHOLDERS DK**



DOPPELKONTAKT
AUFNAHMEN DK



ОПРАВКИ
DK



PORTE-OUTILS
DOUBLE CONTACT DK



MANDRINI
DOPPIO CONTATTO DK



DK 双接触面刀柄





THE NUMEROUS ADVANTAGES OF DOUBLE CONTACT TOOLHOLDER DK:

- Enhanced rigidity thanks to simultaneous fit of taper and flange
- Improvement of the life of the cutting tool
- Improved stability leads to minimized vibration
- Greater bending stiffness allows for higher cutting data, hence higher productivity.



DIE ZAHLREICHEN VORTEILE DES DK:

- Verbesserte Steifigkeit durch die Simultanwirkung des Kontakts des Kegels und des Flansches
- Verbesserung der Lebensdauer des Schneidwerkzeugs
- Verbesserte Stabilität durch eine beachtliche Schwingungssenkung
- Größere Biegesteifigkeit, welche die Produktivität erhöht.



МНОГОЧИСЛЕННЫЕ ДОСТОИНСТВА DK:

- Повышение твердости благодаря синхронному действию контактов
- Продление срока годности
- Повышение стабильности вследствие снижения вибрации
- Повышение прочности при изгибе для улучшения качества обработки.



LES NOMBREUX AVANTAGES DE DK:

- Amélioration de la rigidité grâce au contact au niveau du cône et au niveau de la collerette
- Amélioration de la durée de vie de l'outil de coupe
- Amélioration de la stabilité grâce à la réduction des vibrations
- Grande résistance à la flexion qui permet d'augmenter les conditions de coupe et la productivité.



I NUMEROSI VANTAGGI DEL MANDRINO DOPPIO CONTATTO DK

- Maggiore rigidità grazie all'azione simultanea del contatto conico e di quello a flangia
- Miglioramento della vita dell'utensile di taglio
- Maggiore stabilità grazie alla riduzione delle vibrazioni
- Maggiore resistenza alla flessione per aumentare i dati di taglio e, quindi, la produttività.



DK 刀头的优点:

- 得益于刀柄和法兰的同时配合产品的刚性大大提高
- 切削工具的寿命得以延长
- 更少的震动从而稳定性得以提高
- 更大的抗弯刚度从而提高了生产能力

DOPPELKONTAKT AUFNAHMEN ER SPANNZANGENFUTTER
 DOUBLE CONTACT ER COLLET CHUCK
 ЦАНГОВЫЙ ПАТРОН ER С ДВОЙНЫМ КОНТАКТОМ

MADRINS DOUBLE CONTACT PORTE-PINCE ER
 MANDRINI PORTAPINZA A DOPPIO CONTATTO TIPO ER
 ER双向夹头

MAS 403/BT AD/B

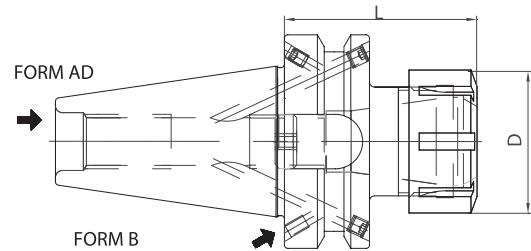
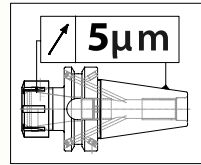

Code N.	Description	ISO	ER	D	L	G2,5 30000 RPM
214-37201	BT30H70ER16 AD	30	16	32	70	•
214-37202	BT30H70ER20 AD	30	20	35	70	•
214-37203	BT30H70ER25 AD	30	25	42	70	•
214-37204	BT30H70ER32 AD	30	32	50	70	•
214-37205	BT40H70ER16 AD+B	40	16	32	70	•
214-37206	BT40H70ER25 AD+B	40	25	42	70	•
214-37207	BT40H70ER32 AD+B	40	32	50	70	•
214-37208	BT40H70ER40 AD+B	40	40	63	70	•
214-37209	BT40H100ER16 AD+B	40	16	32	100	•
214-37210	BT40H100ER25 AD+B	40	25	42	100	•
214-37211	BT40H100ER32 AD+B	40	32	50	100	•
214-37212	BT40H100ER40 AD+B	40	40	63	100	•
214-37213	BT50H80ER32 AD+B	50	32	50	80	•
214-37214	BT50H80ER40 AD+B	50	40	63	80	•
214-37215	BT50H100ER32 AD+B	50	32	50	100	•
214-37216	BT50H100ER40 AD+B	50	40	63	100	•
214-37217	BT50H160ER32 AD+B	50	32	50	160	•
214-37218	BT50H200ER32 AD+B	50	32	50	200	•

Nut

1



ER16	812-203080
ER20	812-203081
ER25	812-203082
ER32	812-203083
ER40	812-203084

DOPPELKONTAKT AUFNAHMEN ER SPANNZANGENFUTTER
 DOUBLE CONTACT ER COLLET CHUCK
 ЦАНГОВЫЙ ПАТРОН ER С ДВОЙНЫМ КОНТАКТОМ

MADRINS DOUBLE CONTACT PORTE-PINCE ER
 MANDRINI PORTAPINZA A DOPPIO CONTATTO TIPO ER
 ER双向夹头

DIN 69871 AD/B

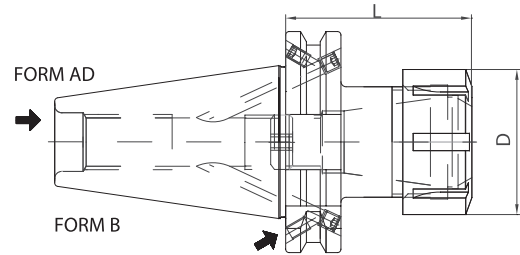
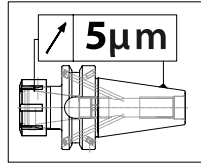

Code N.	Description	ISO	ER	D	L	G2,5 30000 RPM
214-37101	TC40H70ER16 AD+B	40	16	32	70	•
214-37102	TC40H70ER25 AD+B	40	25	42	70	•
214-37103	TC40H70ER32 AD+B	40	32	50	70	•
214-37104	TC40H70ER40 AD+B	40	40	63	70	•
214-37105	TC40H100ER16 AD+B	40	16	32	100	•
214-37106	TC40H100ER25 AD+B	40	25	42	100	•
214-37107	TC40H100ER32 AD+B	40	32	50	100	•
214-37108	TC40H100ER40 AD+B	40	40	63	100	•
214-37109	TC50H70ER32 AD+B	50	32	50	70	•
214-37110	TC50H80ER40 AD+B	50	40	63	80	•
214-37111	TC50H100ER32 AD+B	50	32	50	100	•
214-37112	TC50H100ER40 AD+B	50	40	63	100	•
214-37113	TC50H160ER32 AD+B	50	32	50	160	•
214-37114	TC50H200ER32 AD+B	50	32	50	200	•

Nut

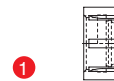

ER16	812-203080
ER20	812-203081
ER25	812-203082
ER32	812-203083
ER40	812-203084

DOPPELKONTAKT AUFNAHMEN AUFSTÄCKFRÄSDORNE
 DOUBLE CONTACT FACE MILL HOLDERS-TENONS DRIVE
 ОПРАВКИ ДЛЯ НАСАДНЫХ ФРЕЗ С ДВОЙНЫМ КОНТАКТОМ

MADRINS DOUBLE CONTACT PORTE-FRAISE
 MANDRINI PORTAFRESE A DOPPIO CONTATTO A TRASCINAMENTO FISSO
 双向铣刀柄

MAS 403/BT AD/B

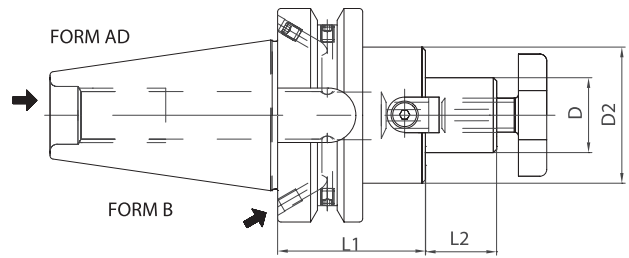

Code N.	Description	ISO	D	L1	L2	D2	G2,5 25000 RPM
216-77207	BT30H35D16 AD	30	16	35	17	38	•
216-77201	BT30H45D22F AD	30	22	45	19	48	•
216-77202	BT30H45D27F AD	30	27	45	21	60	•
217-77208	BT40H45D16 AD+B	40	16	45	17	38	•
216-77203	BT40H45D22F AD+B	40	22	45	19	48	•
216-77204	BT40H60D22F AD+B	40	22	60	19	48	•
216-77205	BT40H45D27F AD+B	40	27	45	21	60	•
216-77206	BT40H60D27F AD+B	40	27	60	21	60	•
216-77210	BT50H60D16F AD+B	50	16	60	17	38	•
216-77211	BT50H60D22F AD+B	50	22	60	19	48	•
216-77212	BT50H60D27F AD+B	50	27	60	21	60	•

DOPPELCONTACT AUFNAHMEN AUFSTÄCKFRÄSDORNE MADRINS DOUBLE CONTACT PORTE-FRAISE
 DOUBLE CONTACT FACE MILL HOLDERS-TENONS DRIVE MANDRINI PORTAFRESE A DOPPIO CONTATTO A TRASCINAMENTO FISSO
 ОПРАВКИ ДЛЯ НАСАДНЫХ ФРЕЗ С ДВОЙНЫМ КОНТАКТОМ 双向铣刀柄

DIN 69871 AD/B

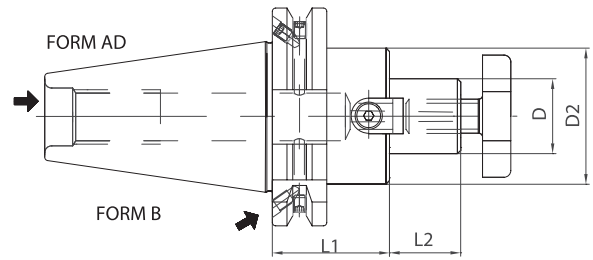

Code N.	Description	ISO	D	L1	L2	D2	G2,5 25000 RPM
216-77103	TC40H35D16F AD+B	40	16	35	17	38	•
216-77101	TC40H35D22F AD+B	40	22	35	19	48	•
216-77102	TC40H60D27F AD+B	40	27	60	21	58	•
216-77104	TC50H45D16F AD+B	50	16	45	17	38	•
216-77105	TC50H45D22F AD+B	50	22	45	19	48	•
216-77106	TC50H60D27F AD+B	50	27	60	21	58	•

Ersatzteile • Spare parts • Pièces détachées • Componenti • Запасные части • 零件

D	Cross screw	Cross screw on enquiry	Tenon	Screw	Wrench
16	811-107003	811-107013	814-202280	811-101004	816-130002
22	811-107004	811-107014	814-202250	811-101011	816-130003
27	811-107005	811-107015	814-202270	811-101018	816-130004
32	811-107006	811-107016	814-202630	811-101029	816-130005
40	811-107007	811-107017	814-202710	811-101029	816-130006

DOPPELCONTACT AUFNAHMEN WELDON
 DOUBLE CONTACT END MILL HOLDERS WELDON
 ОПРАВКИ С КРЕПЛЕНИЕМ WELDON С ДВОЙНЫМ КОНТАКТОМ

MADRINS DOUBLE CONTACT WELDON
 MANDRINI PORTAFRESE A DOPPIO CONTATTO TIPO WELDON
 WELDON双向铣刀柄

MAS 403/BT AD/B

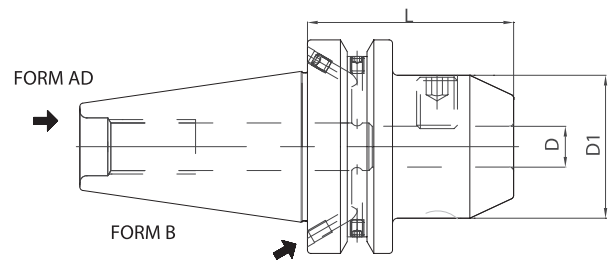

Code N.	Description	ISO	D	L	D1	G6,3 15000 RPM
213-17225	BT30H60WE06 AD	30	6	60	25	•
213-17226	BT30H60WE08 AD	30	8	60	28	•
213-17227	BT30H60WE10 AD	30	10	60	35	•
213-17228	BT30H60WE12 AD	30	12	60	42	•
213-17229	BT30H75WE16 AD	30	16	75	48	•
213-17230	BT30H75WE20 AD	30	20	75	52	•
213-17231	BT30H90WE25 AD	30	25	90	65	•
213-17232	BT40H50WE06 AD+B	40	6	50	25	•
213-17233	BT40H50WE08 AD+B	40	8	50	28	•
213-17234	BT40H63WE10 AD+B	40	10	63	35	•
213-17235	BT40H63WE12 AD+B	40	12	63	42	•
213-17236	BT40H63WE16 AD+B	40	16	63	48	•
213-17237	BT40H63WE18 AD+B	40	18	63	50	•
213-17238	BT40H63WE20 AD+B	40	20	63	52	•
213-17239	BT40H100WE25 AD+B	40	25	100	65	•
213-17240	BT40H100WE32 AD+B	40	32	100	72	•
213-17249	BT50H63WE06 AD+B	50	6	63	25	•
213-17250	BT50H63WE08 AD+B	50	8	63	28	•
213-17251	BT50H70WE10 AD+B	50	10	70	35	•
213-17252	BT50H80WE12 AD+B	50	12	80	42	•
213-17253	BT50H80WE16 AD+B	50	16	80	48	•
213-17254	BT50H80WE18 AD+B	50	18	80	50	•
213-17255	BT50H80WE20 AD+B	50	20	80	52	•
213-17256	BT50H100WE25 AD+B	50	25	100	65	•
213-17257	BT50H105WE32 AD+B	50	32	105	72	•
213-17258	BT50H120WE40 AD+B	50	40	120	80	•

DOPPELKONTAKT AUFNAHMEN WELDON
 DOUBLE CONTACT END MILL HOLDERS WELDON
 ОПРАВКИ С КРЕПЛЕНИЕМ WELDON С ДВОЙНЫМ КОНТАКТОМ

MADRINS DOUBLE CONTACT WELDON
 MANDRINI PORTAFRESE A DOPPIO CONTATTO TIPO WELDON
 WELDON双向铣刀柄

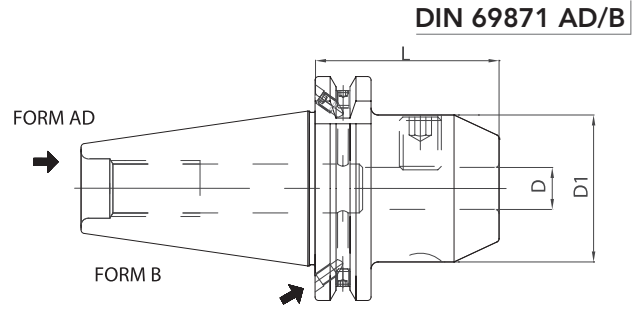

Code N.	Description	ISO	D	L	D1	G6,3 15000 RPM
213-17113	TC40H50WE06 AD+B	40	6	50	25	•
213-17114	TC40H50WE08 AD+B	40	8	50	28	•
213-17115	TC40H50WE10 AD+B	40	10	50	35	•
213-17116	TC40H50WE12 AD+B	40	12	50	42	•
213-17117	TC40H63WE16 AD+B	40	16	63	48	•
213-17118	TC40H63WE18 AD+B	40	18	63	50	•
213-17119	TC40H63WE20 AD+B	40	20	63	52	•
213-17120	TC40H100WE25 AD+B	40	25	100	65	•
213-17121	TC40H100WE32 AD+B	40	32	100	72	•
213-17122	TC50H63WE06 AD+B	50	6	63	25	•
213-17123	TC50H63WE08 AD+B	50	8	63	28	•
213-17124	TC50H63WE10 AD+B	50	10	63	35	•
213-17125	TC50H63WE12 AD+B	50	12	63	42	•
213-17126	TC50H63WE16 AD+B	50	16	63	48	•
213-17127	TC50H63WE18 AD+B	50	18	63	50	•
213-17128	TC50H63WE20 AD+B	50	20	63	52	•
213-17129	TC50H80WE25 AD+B	50	25	80	65	•
213-17130	TC50H100WE32 AD+B	50	32	100	72	•
213-17131	TC50H120WE40 AD+B	50	40	120	80	•

DOPPELKONTAKT AUFNAHMEN SCHRUMPFUTTER MADRINS DOUBLE CONTACT DE FRETAGE
 CONTACT SHRINK FIT CHUCKS MANDRINI A DOPPIO CONTATTO A CALETTAMENTO
 ТЕРМОЗАЖИМНЫЕ ПАТРОНЫ С ДВОЙНЫМ КОНТАКТОМ 双向热缩刀柄

MAS 403/BT AD/B

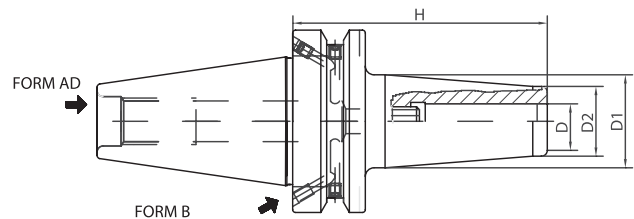

Code N.	Description	ISO	D	H	D1	D2	G2,5 25000 RPM
251-17201	BT40H90K06-HTT	40	6	90	26	21	•
251-17202	BT40H90K08-HTT	40	8	90	26	21	•
251-17203	BT40H90K10-HTT	40	10	90	29	24	•
251-17204	BT40H90K12-HTT	40	12	90	29	24	•
251-17205	BT40H90K16-HTT	40	16	90	32	27	•
251-17206	BT40H100K20-HTT	40	20	100	38	33	•
251-17207	BT40H100K25-HTT	40	25	100	49	44	•
251-17208	BT40H100K32-HTT	40	32	100	49	44	•

DOPPELKONTAKT AUFNAHMEN SCHRUMPFUTTER MADRINS DOUBLE CONTACT DE FRETAGE
 DOUBLE CONTACT SHRINK FIT CHUCKS MANDRINI A DOPPIO CONTATTO A CALETTAMENTO
 ТЕРМОЗАЖИМНЫЕ ПАТРОНЫ С ДВОЙНЫМ КОНТАКТОМ 双向热缩刀柄

DIN 69871 AD/B

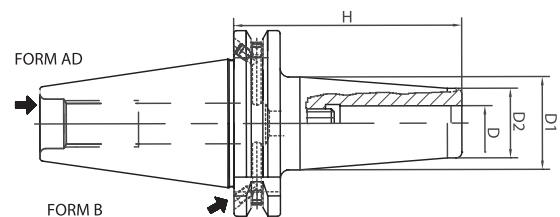

Code N.	Description	ISO	D	H	D1	D2	G2,5 25000 RPM
251-17101	TC40H90K06-HTT	40	6	90	26	21	•
251-17102	TC40H90K08-HTT	40	8	90	26	21	•
251-17103	TC40H90K10-HTT	40	10	90	29	24	•
251-17104	TC40H90K12-HTT	40	12	90	29	24	•
251-17105	TC40H90K16-HTT	40	16	90	32	27	•
251-17106	TC40H100K20-HTT	40	20	100	38	33	•
251-17107	TC40H100K25-HTT	40	25	100	49	44	•
251-17108	TC40H100K32-HTT	40	32	100	49	44	•



pag. 265

KRAFTSPANNFUTTER MANDRINS A FORT SERRAGE
 MILLING CHUCK MANDRINI A FORTE SERRAGGIO
 УСИЛЕННЫЕ ОПРАВКИ 铣夹头

MAS 403/BT A

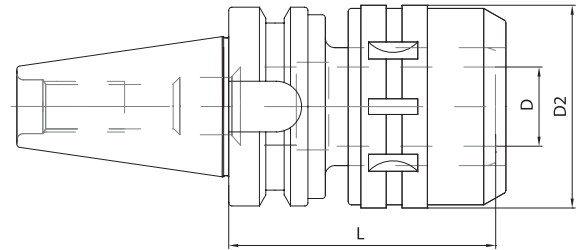

Code N.	Description	ISO	D	D2	L	G6,3 12000 RPM
214-07201	BT40H105C20	40	20	54	105	•
214-07202	BT40H105C32	40	32	72	105	•
214-07203	BT50H105C20	50	20	54	105	•
214-07204	BT50H105C32	50	32	72	105	•
214-07205	BT50H135C32	50	32	72	135	•

KRAFTSPANNFUTTER MANDRINS A FORT SERRAGE
 MILLING CHUCK MANDRINI A FORTE SERRAGGIO
 УСИЛЕННЫЕ ОПРАВКИ 铣夹头

DIN 68971

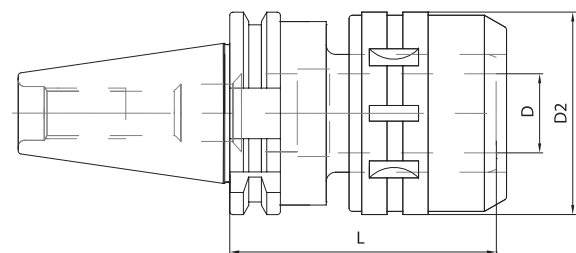

Code N.	Description	ISO	D	D2	L	G6,3 12000 RPM
214-07101	TC40H105C20	40	20	54	105	•
214-07102	TC40H105C32	40	32	72	105	•

KRAFTSPANNFUTTERSATZ JEUX À FORT SERRAGE
 MILLING CHUCK KITS KIT FORTE SERRAGGIO
 НАБОРЫ СИЛОВЫХ ПАТРОНОВ С ЦАНГАМИ К НИМ 铣夹头组套

Ausstattungskasten: 1 Kraftspannfutter + 1 Spannzangensatz + 1 Spannschlüssel

Kit Box: 1 milling chuck + 1 collets kit + 1 wrench

Набор: 1 патрон + 1 набор цанг + 1 ключ

Boîte d'équipement: 1 mandrin à fort serrage + 1 jeux de pince + 1 clé

Cassetta Corredo: 1 mandrino forte serraggio + 1 serie pinze + 1 chiave

组件盒: 1 个铣夹头 + 1 个夹头套装 + 1 个扳手



	CODICE ORDINAZIONE <i>Order Code</i>	COMPOSIZIONE <i>Composition</i>
ISO 40	KIT BT40 C20DK	N°1 BT40 L105 C20 + n°5 pinze K20: Ø6,8,10,12,16
	KIT BT40 C32DK	N°1 BT40 L105 C32 + n°7 pinze K32: Ø6,8,10,12,16,20,25
	KIT TC40 C20DK	N°1 TC 40 L105 C20 + n°5 pinze K20: Ø6,8,10,12,16
	KIT TC40 C32DK	N°1 TC 40 L105 C32 + n°7 pinze K32: Ø6,8,10,12,16,20,25
	KIT BT50 C20DK	N°1 BT50 L105 C20 + n°5 pinze K20: 6,8,10,12,16
	KIT BT50 C32DK	N°1 BT50 L105 C32 + n°7 pinze K32: 6,8,10,12,16,20,25

REDUKTION SK 40/50 DIN69871 MIT POLYGONSCHAFT
 REDUCTION ISO 40/50 DIN69871-AD/B - POLYGONAL SHANK
 ПЕРЕХОДНИКИ С ISO 40/50 DIN69871-AD/B НА EPS

REDUCTION ISO 40/50 DIN69871 AVEC ATTACHEMENT POLYGONALE
 RIDUZIONE ISO 40/50 DIN 69871-AD/B PER ATTACCO POLIGONALE
 DIN69871-AD/B多边形缩减柄

DIN 69871

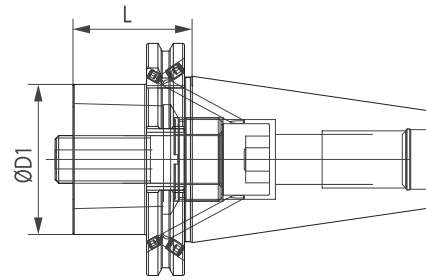

Code N.	Attacco Shank	D1mm	Lmm
TC40H30C32DK	40DIN69871 AD/B	32	30
TC40H40C40DK	40DIN69871 AD/B	40	40
TC40H50C50DK	40DIN69871 AD/B	50	50
TC40H85C63DK	40DIN69871 AD/B	63	85
TC50H60C32DK	50DIN69871 AD/B	32	60
TC50H30C40DK	50DIN69871 AD/B	40	30
TC50H60C40DK	50DIN69871 AD/B	40	60
TC50H30C50DK	50DIN69871 AD/B	50	30
TC50H70C50DK	50DIN69871 AD/B	50	70
TC50H50C63DK	50DIN69871 AD/B	63	50
TC50H100C63DK	50DIN69871 AD/B	63	100
TC50H70C80DK	50DIN69871 AD/B	80	70
TC50H120C80DK	50DIN69871 AD/B	80	120

REDUKTION BT40/50-AD/B MIT POLYGONSCHAFT
 REDUCTION BT40/50-AD/B - POLYGONAL SHANK
 ПЕРЕХОДНИКИ С BT40/50-AD/B НА DIN

REDUCTION BT40/50-AD/B AVEC ATTACHEMENT POLYGONALE
 RIDUZIONE BT40/50-AD/B CON ATTACCO POLIGONALE
 BT40/50-AD/B多边形缩减柄

JIS-B 6339 MAS 403/BT

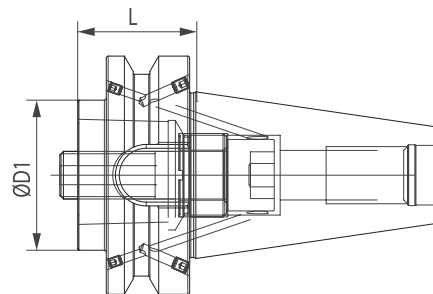

Code N.	Attacco Shank	D1mm	Lmm
BT40H30C32DK	40DIN69871 AD/B	32	30
BT40H40C40DK	40DIN69871 AD/B	40	40
BT40H50C50DK	40DIN69871 AD/B	50	50
BT40H75C63DK	40DIN69871 AD/B	63	75
BT50H70C32DK	50DIN69871 AD/B	32	70
BT50H40C40DK	50DIN69871 AD/B	40	40
BT50H70C40DK	50DIN69871 AD/B	40	70
BT50H40C50DK	50DIN69871 AD/B	50	40
BT50H80C50DK	50DIN69871 AD/B	50	80
BT50H50C63DK	50DIN69871 AD/B	63	50
BT50H100C63DK	50DIN69871 AD/B	63	100
BT50H70C80DK	50DIN69871 AD/B	80	70
BT50H120C80DK	50DIN69871 AD/B	80	120

DOPPELKONTAKT VIERKANTWERKZEUGHALTER
 DOUBLE CONTACT SQUARE TOOLHOLDER
 ОПРАВКА ДК С КВАДРАТОМ

PORTE OUTIL CARRÉ À DOUBLE CONTACT
 PORTABARENO QUADRO DOPPIO CONTATTO
 双触面方形刀柄

MAS 403/BT

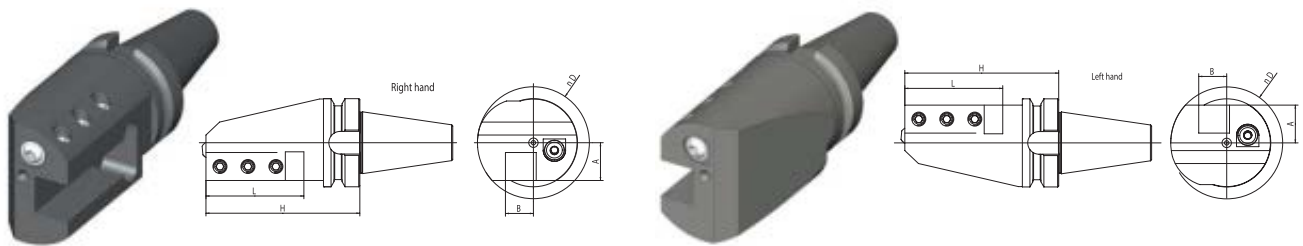

Code N.	Description	ISO	B	H	L	A	D
152-11510	BT40H110-2020R	40	20	110	70	27	80
152-21502	BT40H110-2020L	40	20	110	70	27	80
152-11511	BT40H130-2525R	40	25	130	90	31,5	90
152-21503	BT40H130-2525L	40	25	130	90	31,5	90
152-11512	BT50H140-2525R	50	25	140	90	50	120
152-21504	BT50H140-2525L	50	25	140	90	50	120

DOPPELKONTAKT DREIFACH-VIERKANTWERKZEUGHALTER
 DOUBLE CONTACT TRIPLE SQUARE TOOLHOLDER
 ОПРАВКА ДК С ТРОЙНЫМ КВАДРАТОМ

PORTE OUTIL CARRÉ À DOUBLE CONTACT TRIPLE
 PORTABARENO TRIPLO DOPPIO CONTATTO
 双触面三方刀柄

MAS 403/BT

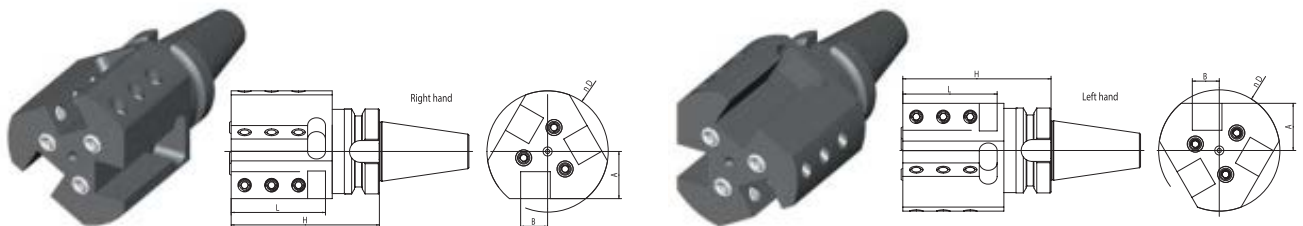

Code N.	Description	ISO	B	H	L	A	D
152-11513	BT40H110-3X2020R	40	20	110	70	35	90
152-21505	BT40H110-3X2020L	40	20	110	70	35	90
152-11514	BT50H140-3X2525R	50	25	140	90	50	120
152-21506	BT50H140-3X2525L	50	25	140	90	50	120

DOPPELKONTAKT BOHRSTANGENHALTER
DOUBLE CONTACT BORING BAR HOLDER
ОПРАВКА ДК ДЛЯ РАСТОЧНЫХ РЕЗЦОВ

PORTE OUTIL POUR BARRES D'ALESAGES À DOUBLE CONTACT
PORTABARENO DOPPIO CONTATTO
双触面镗刀柄

MAS 403/BT

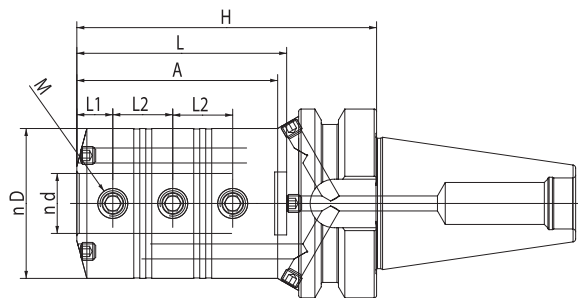

Code N.	Description	ISO	d	D	H	L1	L2	L	A	M	PlugA	PlugB
155-21518	BT40H80D10BSL	40	10	29	80	8	12	50	45	M8x1	M6x5	M5x5
155-21519	BT40H90D12BSL	40	12	34	90	8	16	55	53	M8x1	M6x5	M6x5
155-21520	BT40H100D16BSL	40	16	40	100	10	21	68	65	M10x1,25	M6x5	M6x5
155-21521	BT40H100D20BSL	40	20	50	100	12	20	70	67	M10x1,25	M6x5	M6x5
155-21522	BT40H110D25BSL	40	25	55	110	14	23	74	83	M12x1,5	M8x8	M6x5
155-21523	BT40H125D32BSL	40	32	64	125	16	26	83	-	M12x1,5	M8x8	M6x5
155-21524	BT50H100D12BSL	50	12	34	100	8	16	55	53	M8x1	M6x5	M6x5
155-21525	BT50H105D16BSL	50	16	40	105	10	21	68	61	M10x1,25	M6x5	M6x5
155-21526	BT50H110D20BSL	50	20	50	110	12	20	70	60	M10x1,25	M6x5	M6x5
155-21527	BT50H120D25BSL	50	25	55	120	14	23	74	70	M12x1,5	M8x8	M6x5
155-21528	BT50H125D32BSL	50	32	64	125	16	26	83	80	M12x1,5	M8x8	M6x5

GEWINDESCHNEID-SCHNELLWECHSELFUTTER
MIT LÄNGENAUSGLEICH
TENSION AND COMPRESSION TAPPING HEAD
РЕЗЬБОНАРЕЗНЫЕ ПАТРОНЫ С КОМПЕНСАЦИЕЙ

MANDRINS DE TARAUDAGE A CHANGEMENT
RAPIDE A DOUBLE USAGE
MASCHIATORI A DOPPIA COMPENSAZIONE
张力和压缩丝攻头

DIN 69871 A

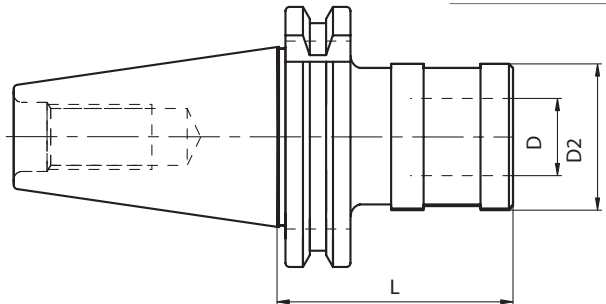

Code N.	Description	ISO	SIZE	Top-range	PRESS.	EXT.	D	D2	L
M3140	TC40H59GR1-DK	40	1	M3-M12	9	9	19	38	59
M3150	TC40H99GR2-DK	40	2	M6-M20	15	15	31	55	99
M3160	TC50H61GR1-DK	50	1	M3-M12	9	9	19	38	61
M3170	TC50H82GR2-DK	50	2	M6-M20	15	15	31	55	82

Zubehör
Accessories
Accessoires
Accessori
Принадлежности
零件



pag. 233

pag. 234

GEWINDESCHNEID-SCHNELLWECHSELFUTTER
MIT LÄNGENAUSGLEICH
TENSION AND COMPRESSION TAPPING HEAD
РЕЗЬБОНАРЕЗНЫЕ ПАТРОНЫ С КОМПЕНСАЦИЕЙ

MANDRINS DE TARAUDAGE A CHANGEMENT
RAPIDE A DOUBLE USAGE
MASCHIATORI A DOPPIA COMPENSAZIONE
张力和压缩丝攻头

JIS-B 6339 MAS 403/BT A

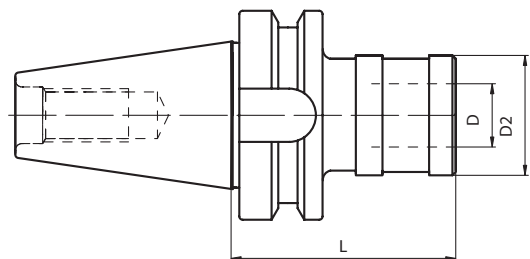

Code N.	Description	ISO	SIZE	Top-range	PRESS.	EXT.	D	D2	L
M3330	BT40H59GR1-DK	40	1	M3-M12	9	9	19	38	68
M3340	BT40H99GR2-DK	40	2	M6-M20	15	15	31	55	93
M3350	BT50H61GR1-DK	50	1	M3-M12	9	9	19	38	78
M3360	BT50H82GR2-DK	50	2	M6-M20	15	15	31	55	100

Zubehör
Accessories
Accessoires
Accessori
Принадлежности
零件



pag. 233

pag. 234

ROHLINGE MIT WEICHEM SCHAFT
BLANK TOOLHOLDER WITH SOFT SHANK
ЗАГОТОВКИ ДЛЯ ОПРАВОК НЕЗАКАЛЕННЫЕ

BARRES D'ALESAGE SEMI-FINIES
MANDRINI SEMILAVORATI A STELO TENERO
带软柄的切断刀柄

MAS BT

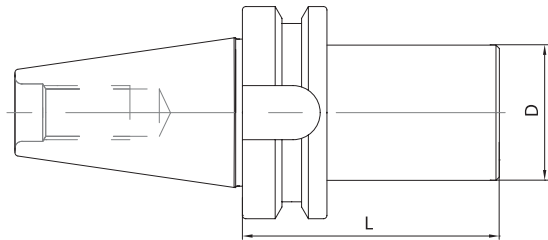
**HRC26-28**

Code N.	Description	ISO	D	L
217-47201	BT30H160D52SM	30	52	160
217-47202	BT40H160D63.5SM	40	63.5	160

HRC42

Code N.	Description	ISO	D	L
217-47201HRC42	BT30H160D52SM	30	52	160
217-47202HRC42	BT40H160D63.5SM	40	63.5	160

ROHLINGE MIT WEICHEM SCHAFT
BLANK TOOLHOLDER WITH SOFT SHANK
ЗАГОТОВКИ ДЛЯ ОПРАВОК НЕЗАКАЛЕННЫЕ

BARRES D'ALESAGE SEMI-FINIES
MANDRINI SEMILAVORATI A STELO TENERO
带软柄的切断刀柄

DIN69871

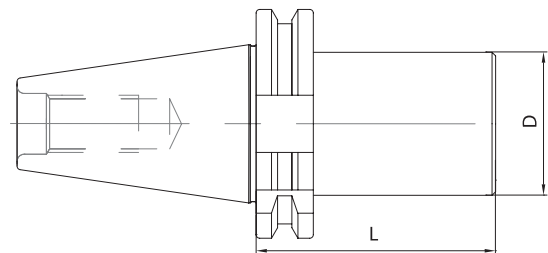
**HRC26-28**

Code N.	Description	ISO	D	L
217-47101	TC40H160D63.5SM	40	63.5	160

HRC42

Code N.	Description	ISO	D	L
217-47101HRC42	TC40H160D63.5SM	40	63.5	160