

KINTEK

SHRINK FIT CHUCKS

MANDRINI A CALETTAMENTO



**SHRINK
FIT CHUCKS** 

SCHRUMPFUTTER 

ТЕРМОЗАЖИМНЫЕ
ПАТРОНЫ 

MANDRINS
DE FRETAGE 

MANDRINI
A CALETTAMENTO 

热缩刀柄 

SHRINK FIT CHUCKS
DIN 69871
MAS 403/BT
DIN 69893



SCHRUMPFUTTER ISO 40 DIN 69871 AD/B
 SHRINK FIT CHUCKS ISO 40 DIN 69871 AD/B
 ТЕРМОЗАЖИМНЫЕ ПАТРОНЫ ISO 40 ПО DIN 69871 ТИП AD/B

MANDRINS DE FRETTAGE TYPE ISO 40 DIN 69871 AD/B
 MANDRINI A CALETTAMENTO ISO 40 DIN 69871 AD/B
 热缩刀柄 ISO 40 DIN 69871 AD/B

DIN 69871 AD/B

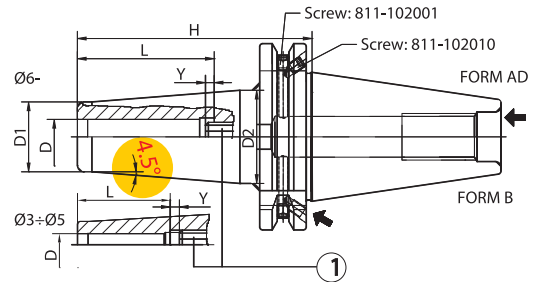
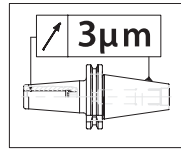

4.5° PROGRAMME

	Code N.	Description	D	H	L	Ymax	D1	D2	G2,5 25000
STANDARD	251-11232	TC40H80K03-HTT	3	80	22	10	10	17	•
	251-11225	TC40H80K04-HTT	4	80	26	10	15	22	•
	251-11233	TC40H80K05-HTT	5	80	30	10	15	22	•
	251-11201	TC40H80K06-HTT	6	80	36	10	21	27	•
	251-11202	TC40H80K08-HTT	8	80	36	10	21	27	•
	251-11203	TC40H80K10-HTT	10	80	41	10	24	32	•
	251-11204	TC40H80K12-HTT	12	80	47	10	24	32	•
	251-11206	TC40H80K14-HTT	14	80	47	10	27	34	•
	251-11205	TC40H80K16-HTT	16	80	50	10	27	34	•
	251-11207	TC40H80K18-HTT	18	80	50	10	33	42	•
	251-11208	TC40H80K20-HTT	20	80	52	10	33	42	•
	251-11218	TC40H100K25-HTT	25	100	58	10	44	53	•
251-21233	TC40H100K32-HTT	32	100	62	10	44	53	•	
H 120	251-11295	TC40H120K03-HTT	3	120	22	10	10	20	•
	251-11296	TC40H120K04-HTT	4	120	26	10	15	22	•
	251-11297	TC40H120K05-HTT	5	120	30	10	15	22	•
	251-11209	TC40H120K06-HTT	6	120	36	10	21	27	•
	251-11210	TC40H120K08-HTT	8	120	36	10	21	27	•
	251-11211	TC40H120K10-HTT	10	120	41	10	24	32	•
	251-11212	TC40H120K12-HTT	12	120	47	10	24	32	•
	251-21201	TC40H120K14-HTT	14	120	47	10	27	34	•
	251-11298	TC40H120K16-HTT	16	120	50	10	27	34	•
	251-21234	TC40H120K18-HTT	18	120	50	10	33	42	•
	251-21235	TC40H120K20-HTT	20	120	52	10	33	42	•
	251-21236	TC40H120K25-HTT	25	120	58	10	44	53	•
251-21237	TC40H120K32-HTT	32	120	62	10	44	53	•	
H 160	251-21238	TC40H160K03-HTT	3	160	22	10	10	20	•
	251-21239	TC40H160K04-HTT	4	160	26	10	15	22	•
	251-21240	TC40H160K05-HTT	5	160	30	10	15	22	•
	251-21241	TC40H160K06-HTT	6	160	36	10	21	27	•
	251-21242	TC40H160K08-HTT	8	160	36	10	21	27	•
	251-21243	TC40H160K10-HTT	10	160	41	10	24	32	•
	251-21244	TC40H160K12-HTT	12	160	47	10	24	32	•
	251-21245	TC40H160K14-HTT	14	160	47	10	27	34	•
	251-21246	TC40H160K16-HTT	16	160	50	10	27	34	•
	251-21247	TC40H160K18-HTT	18	160	50	10	33	42	•
	251-21248	TC40H160K20-HTT	20	160	52	10	33	42	•
	251-21249	TC40H160K25-HTT	25	160	62	10	44	53	•
251-21250	TC40H160K32-HTT	32	160	62	10	44	53	•	

SCHRUMPFUTTER ISO 40 DIN 69871 AD/B
SHRINK FIT CHUCKS ISO 40 DIN 69871 AD/B
ТЕРМОЗАЖИМНЫЕ ПАТРОНЫ ISO 40 ПО DIN 69871 ТИП AD/B

MANDRINS DE FRETTAGE TYPE ISO 40 DIN 69871 AD/B
MANDRINI A CALETTAMENTO ISO 40 DIN 69871 AD/B
热缩刀柄 ISO 40 DIN 69871 AD/B

DIN69871

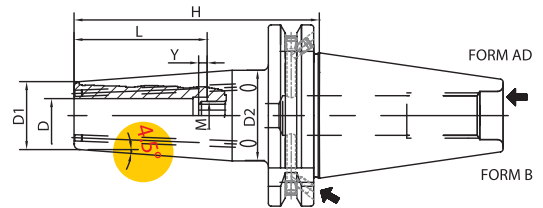
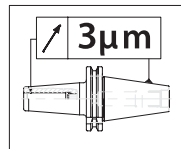

4,5° PROGRAMME WITH RESEALABLE COOLANT DUCT HOLES

4,5° CON PASSAGGIO REFRIGERANTE MEDIANTE CANALI ESTERNI RICHIUDIBILI

	Code N.	Description	D	H	L	Ymax	D1	D2	M	SW	G2,5 25000
STANDARD	251-31218	TC40H80K03-HTT-L	3	80	28	16	10	17	M6	2	•
	251-31219	TC40H80K04-HTT-L	4	80	28	12	15	22	M6	2	•
	251-31220	TC40H80K05-HTT-L	5	80	30	10	15	22	M6	2	•
	251-31221	TC40H80K06-HTT-L	6	80	36	10	21	27	M5	2,5	•
	251-31222	TC40H80K08-HTT-L	8	80	36	10	21	27	M6	3	•
	251-31223	TC40H80K10-HTT-L	10	80	41	10	24	32	M8x1	3	•
	251-31224	TC40H80K12-HTT-L	12	80	47	10	24	32	M10x1	5	•
	251-31225	TC40H80K14-HTT-L	14	80	47	10	27	34	M10x1	5	•
	251-31226	TC40H80K16-HTT-L	16	80	50	10	27	34	M12x1	5	•
	251-31227	TC40H80K18-HTT-L	18	80	50	10	33	42	M12x1_KKB	5	•
	251-31228	TC40H80K20-HTT-L	20	80	52	10	33	42	M16x1_KKB	5	•
	251-31229	TC40H100K25-HTT-L	25	100	58	10	44	53	M16x1	8	•
	251-31230	TC40H100K32-HTT-L	32	100	62	10	44	53	M16x1_KKB	5	•

SCHRUMPFUTTER ISO 40 DIN 69871 AD/B
SHRINK FIT CHUCKS ISO 40 DIN 69871 AD/B
ТЕРМОЗАЖИМНЫЕ ПАТРОНЫ ISO 40 ПО DIN 69871 ТИП AD/B

MANDRINS DE FRETTAGE TYPE ISO 40 DIN 69871 AD/B
MANDRINI A CALETTAMENTO ISO 40 DIN 69871 AD/B
热缩刀柄 ISO 40 DIN 69871 AD/B

DIN69871

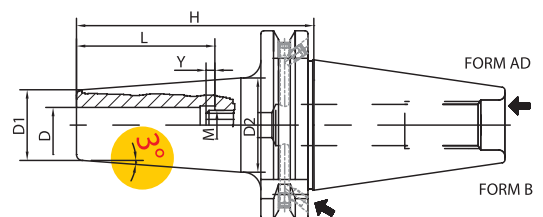
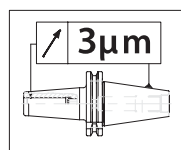

3° PROGRAMME

	Code N.	Description	D	H	L	Ymax	D1	D2	M	SW	G2,5 25000
STANDARD	251-21284	TC40H80K03-HTT	3	80	28	16	9	14	M6	2	•
	251-21285	TC40H80K04-HTT	4	80	28	12	10	15	M6	2	•
	251-21286	TC40H80K05-HTT	5	80	30	10	11	16	M6	2	•
	251-21287	TC40H80K06-HTT	6	80	36	10	12	17	M5	2,5	•
	251-21288	TC40H80K08-HTT	8	80	36	10	14	19	M6	3	•
	251-21289	TC40H80K10-HTT	10	80	41	10	16	21	M8x1	3	•
	251-21290	TC40H80K12-HTT	12	80	47	10	18	23	M10x1	5	•
	251-21291	TC40H80K14-HTT	14	80	47	10	20	26	M10x1	5	•
	251-21292	TC40H80K16-HTT	16	80	50	10	22	28	M12x1	5	•
	251-21293	TC40H80K18-HTT	18	80	50	10	24	30	M12x1	5	•
	251-21294	TC40H80K20-HTT	20	80	52	10	26	32	M16x1	8	•

SCHRUMPFUTTER ISO 40 DIN 69871 AD/B
SHRINK FIT CHUCKS ISO 40 DIN 69871 AD/B
ТЕРМОЗАЖИМНЫЕ ПАТРОНЫ ISO 40 ПО DIN 69871 ТИП AD/B

MANDRINS DE FRETTAGE TYPE ISO 40 DIN 69871 AD/B
MANDRINI A CALETTAMENTO ISO 40 DIN 69871 AD/B
热缩刀柄 ISO 40 DIN 69871 AD/B

DIN69871

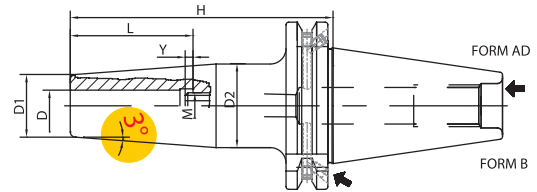
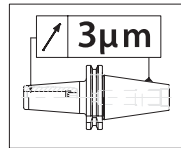

3° PROGRAMME

Code N.	Description	D	H	L	Y _{max}	D1	D2	M	SW	G2,5 2500	
H120	251-21295	TC40H120K03-HTT	3	120	12	-	9	16	-	-	•
	251-21296	TC40H120K04-HTT	4	120	16	-	10	17	-	-	•
	251-21297	TC40H120K05-HTT	5	120	20	-	11	18	-	-	•
	251-21298	TC40H120K06-HTT	6	120	36	10	12	22	M5	2,5	•
	251-21299	TC40H120K08-HTT	8	120	36	10	14	24	M6	3	•
	251-31201	TC40H120K10-HTT	10	120	41	10	16	26	M8x1	3	•
	251-31202	TC40H120K12-HTT	12	120	47	10	18	28	M10x1	5	•
	251-31203	TC40H120K14-HTT	14	120	47	10	20	30	M10x1	5	•
	251-31204	TC40H120K16-HTT	16	120	50	10	22	32	M12x1	5	•
	251-31205	TC40H120K18-HTT	18	120	50	10	24	34	M12x1	5	•
251-31206	TC40H120K20-HTT	20	120	52	10	26	36	M16x1	8	•	
H160	251-31207	TC40H160K03-HTT	3	160	12	-	9	19	-	-	•
	251-31208	TC40H160K04-HTT	4	160	16	-	10	20	-	-	•
	251-31209	TC40H160K05-HTT	5	160	20	-	11	21	-	-	•
	251-31210	TC40H160K06-HTT	6	160	36	10	12	24	M5	2,5	•
	251-31211	TC40H160K08-HTT	8	160	36	10	14	26	M6	3	•
	251-31212	TC40H160K10-HTT	10	160	41	10	16	28	M8x1	3	•
	251-31213	TC40H160K12-HTT	12	160	47	10	18	30	M10x1	5	•
	251-31214	TC40H160K14-HTT	14	160	47	10	20	32	M10x1	5	•
	251-31215	TC40H160K16-HTT	16	160	50	10	22	34	M12x1	5	•
	251-31216	TC40H160K18-HTT	18	160	50	10	24	36	M12x1	5	•
	251-31217	TC40H160K20-HTT	20	160	52	10	26	38	M16x1	8	•

SCHRUMPFUTTER ISO 50 DIN 69871 AD/B MANDRINS DE FRETTAGE TYPE ISO 50 DIN 69871 AD/B
 SHRINK FIT CHUCKS ISO 50 DIN 69871 AD/B MANDRINI A CALETTAMENTO ISO 50 DIN 69871 AD/B
 ТЕРМОЗАЖИМНЫЕ ПАТРОНЫ ISO 50 ПО DIN 69871 ТИП AD/B 热缩刀柄 ISO 50 DIN 69871 AD/B

DIN 69871 AD/B

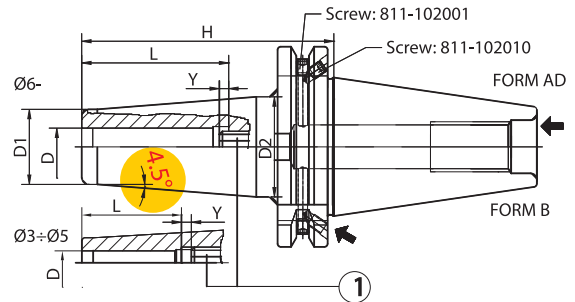
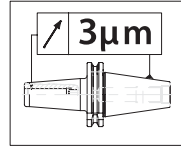

4.5° PROGRAMME

	Code N.	Description	D	H	L	Y _{max}	D1	D2	G2,5 25000
STANDARD	251-21251	TC50H80K03-HTT	3	80	-	-	10	20	•
	251-21252	TC50H80K04-HTT	4	80	-	-	15	25	•
	251-21253	TC50H80K05-HTT	5	80	-	-	15	25	•
	251-11234	TC50H80K06-HTT	6	80	36	10	21	27	•
	251-11235	TC50H80K08-HTT	8	80	36	10	21	27	•
	251-11236	TC50H80K10-HTT	10	80	41	10	24	32	•
	251-11237	TC50H80K12-HTT	12	80	47	10	24	32	•
	251-11238	TC50H80K14-HTT	14	80	47	10	27	34	•
	251-11224	TC50H80K16-HTT	16	80	50	10	27	34	•
	251-11239	TC50H80K18-HTT	18	80	50	10	33	42	•
	251-11240	TC50H80K20-HTT	20	80	52	10	33	42	•
	251-11241	TC50H100K25-HTT	25	100	58	10	44	53	•
	251-21254	TC50H100K32-HTT	32	100	62	10	44	53	•
H120	251-21255	TC50H120K03-HTT	3	120	-	10	10	20	•
	251-21256	TC50H120K04-HTT	4	120	-	10	15	22	•
	251-21257	TC50H120K05-HTT	5	120	-	10	15	22	•
	251-11242	TC50H120K06-HTT	6	120	36	10	21	27	•
	251-11243	TC50H120K08-HTT	8	120	36	10	21	27	•
	251-11244	TC50H120K10-HTT	10	120	41	10	24	32	•
	251-11245	TC50H120K12-HTT	12	120	47	10	24	32	•
	251-11246	TC50H120K14-HTT	14	120	47	10	27	34	•
	251-11247	TC50H120K16-HTT	16	120	50	10	27	34	•
	251-11248	TC50H120K18-HTT	18	120	50	10	33	42	•
	251-11249	TC50H120K20-HTT	20	120	52	10	33	42	•
251-21258	TC50H120K25-HTT	25	120	58	10	44	53	•	
251-21259	TC50H120K32-HTT	32	120	62	10	44	53	•	
H160	251-21260	TC50H160K03-HTT	3	160	-	10	10	20	•
	251-21261	TC50H160K04-HTT	4	160	-	10	15	22	•
	251-21262	TC50H160K05-HTT	5	160	-	10	15	22	•
	251-21263	TC50H160K06-HTT	6	160	36	10	21	27	•
	251-21264	TC50H160K08-HTT	8	160	36	10	21	27	•
	251-21265	TC50H160K10-HTT	10	160	41	10	24	32	•
	251-21266	TC50H160K12-HTT	12	160	47	10	24	32	•
	251-21267	TC50H160K14-HTT	14	160	47	10	27	34	•
	251-21268	TC50H160K16-HTT	16	160	50	10	27	34	•
	251-21269	TC50H160K18-HTT	18	160	50	10	33	42	•
	251-21270	TC50H160K20-HTT	20	160	52	10	33	42	•
	251-21271	TC50H160K25-HTT	25	160	58	10	44	53	•
	251-21272	TC50H160K32-HTT	32	160	62	10	44	53	•

SCHRUMPFUTTER MAS BT-30 FORM AD
SHRINK FIT CHUCKS MAS BT-30 FORM AD
ТЕРМОЗАЖИМНЫЕ ПАТРОНЫ MAS BT-30 ТИП AD

MANDRINS DE FRETTAGE TYPE MAS BT-30 FORM AD
MANDRINI A CALETTAMENTO MAS BT-30 FORM AD
热缩刀柄 MAS BT30 AD型

MAS BT-AD

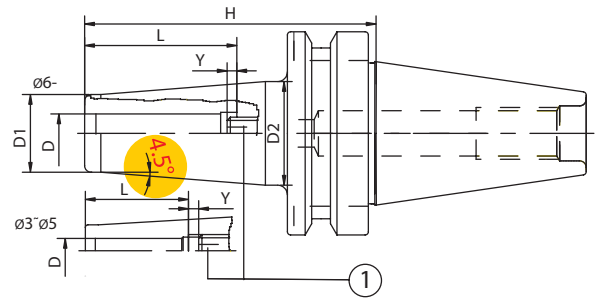
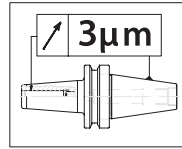

4.5° PROGRAMME

Code N.	Description	D	H	L	Y _{max}	D1	D2	G2,5 25000
251-11564	BT30H85K03-HTT	3	85	22	10	10	20	•
251-11565	BT30H85K04-HTT	4	85	26	10	15	25	•
251-11566	BT30H85K05-HTT	5	85	30	10	15	25	•
251-11567	BT30H85K06-HTT	6	85	36	10	21	27	•
251-11568	BT30H85K08-HTT	8	85	36	10	21	27	•
251-11569	BT30H85K10-HTT	10	85	41	10	24	32	•
251-11570	BT30H85K12-HTT	12	85	47	10	24	32	•
251-11571	BT30H85K14-HTT	14	85	47	10	27	34	•
251-11572	BT30H85K16-HTT	16	85	50	10	27	34	•
251-11588	BT30H85K18-HTT	18	85	50	10	33	42	•
251-11589	BT30H85K20-HTT	20	85	50	10	33	42	•

STANDARD

SCHRUMPFUTTER MAS BT40 FORM AD/B MANDRINS DE FRETTAGE MAS BT40 TYPE AD/B
 SHRINK FIT CHUCKS MAS BT40 AD/B MANDRINI A CALETTAMENTO MAS BT40 TIPO AD/B
 ТЕРМОЗАЖИМНЫЕ ПАТРОНЫ MAS BT-40 ТИП АД/В 热缩刀柄 MAS BT40 AD/B

MAS BT AD/B

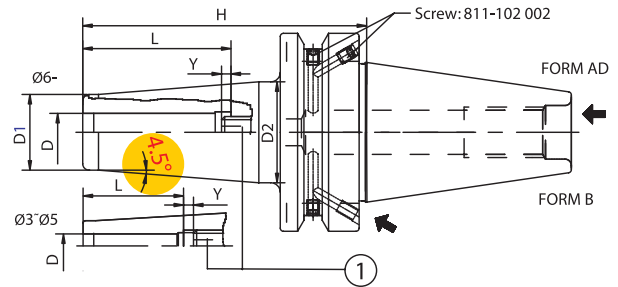
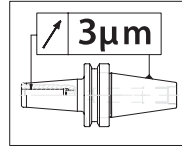

4.5° PROGRAMME

	Code N.	Description	D	H	L	Ymax	D1	D2	G2,5 25000
STANDARD	251-11580	BT40H90K03-HTT	3	90	22	10	10	17	•
	251-11581	BT40H90K04-HTT	4	90	26	10	15	22	•
	251-11582	BT40H90K05-HTT	5	90	30	10	15	22	•
	251-11501	BT40H90K06-HTT	6	90	36	10	21	27	•
	251-11502	BT40H90K08-HTT	8	90	36	10	21	27	•
	251-11503	BT40H90K10-HTT	10	90	41	10	24	32	•
	251-11504	BT40H90K12-HTT	12	90	47	10	24	32	•
	251-11505	BT40H90K14-HTT	14	90	47	10	27	34	•
	251-11506	BT40H90K16-HTT	16	90	50	10	27	34	•
	251-11507	BT40H90K18-HTT	18	90	50	10	33	42	•
	251-11508	BT40H90K20-HTT	20	90	52	10	33	42	•
	251-11547	BT40H100K25-HTT	25	100	58	10	44	53	•
	251-21504	BT40H100K32-HTT	32	100	62	10	44	53	•
H120	251-11583	BT40H120K03-HTT	3	120	22	10	10	20	•
	251-11584	BT40H120K04-HTT	4	120	26	10	15	22	•
	251-11585	BT40H120K05-HTT	5	120	30	10	15	22	•
	251-11509	BT40H120K06-HTT	6	120	36	10	21	27	•
	251-11510	BT40H120K08-HTT	8	120	36	10	21	27	•
	251-11511	BT40H120K10-HTT	10	120	41	10	24	32	•
	251-11512	BT40H120K12-HTT	12	120	47	10	24	32	•
	251-11587	BT40H120K14-HTT	14	120	47	10	27	34	•
	251-11586	BT40H120K16-HTT	16	120	50	10	27	34	•
	251-21505	BT40H120K18-HTT	18	120	50	10	33	42	•
	251-21506	BT40H120K20-HTT	20	120	52	10	33	42	•
251-21507	BT40H120K25-HTT	25	120	58	10	44	53	•	
251-21508	BT40H120K32-HTT	32	120	62	10	44	53	•	
H160	251-21509	BT40H160K03-HTT	3	160	22	10	10	20	•
	251-21510	BT40H160K04-HTT	4	160	26	10	15	22	•
	251-21511	BT40H160K05-HTT	5	160	30	10	15	22	•
	251-21512	BT40H160K06-HTT	6	160	36	10	21	27	•
	251-21513	BT40H160K08-HTT	8	160	36	10	21	27	•
	251-21514	BT40H160K10-HTT	10	160	41	10	24	32	•
	251-21515	BT40H160K12-HTT	12	160	47	10	24	32	•
	251-21516	BT40H160K14-HTT	14	160	47	10	27	34	•
	251-21517	BT40H160K16-HTT	16	160	50	10	27	34	•
	251-21518	BT40H160K18-HTT	18	160	50	10	33	42	•
	251-21519	BT40H160K20-HTT	20	160	52	10	33	42	•
	251-21520	BT40H160K25-HTT	25	160	58	10	44	53	•
	251-21521	BT40H160K32-HTT	32	160	62	10	44	53	•

SCHRUMPFUTTER MAS BT40 FORM AD/B MANDRINS DE FRETTAGE MAS BT40 TYPE AD/B
 SHRINK FIT CHUCKS MAS BT40 AD/B MANDRINI A CALETTAMENTO MAS BT40 TIPO AD/B
 ТЕРМОЗАЖИМНЫЕ ПАТРОНЫ MAS BT-40 ТИП AD/B 热缩刀柄 MAS BT40 AD/B

MAS BT

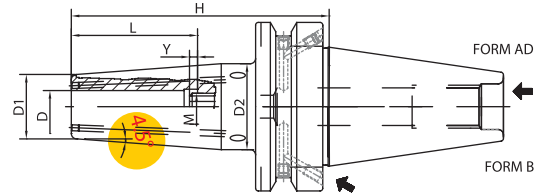
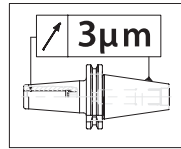

4,5° PROGRAMME WITH RESEALABLE COOLANT DUCT HOLES
4,5° CON PASSAGGIO REFRIGERANTE MEDIANTE CANALI ESTERNI RICHIUDIBILI

	Code N.	Description	D	H	L	Ymax	D1	D2	M	SW	G2,5 25000
STANDARD	251-21579	BT40H90K03-HTT-L	3	90	28	16	10	17	M6	2	•
	251-21580	BT40H90K04-HTT-L	4	90	28	12	15	22	M6	2	•
	251-21581	BT40H90K05-HTT-L	5	90	30	10	15	22	M6	2	•
	251-21582	BT40H90K06-HTT-L	6	90	36	10	21	27	M5	2,5	•
	251-21583	BT40H90K08-HTT-L	8	90	36	10	21	27	M6	3	•
	251-21584	BT40H90K10-HTT-L	10	90	41	10	24	32	M8x1	3	•
	251-21585	BT40H90K12-HTT-L	12	90	47	10	24	32	M10x1_KKB	5	•
	251-21586	BT40H90K14-HTT-L	14	90	47	10	27	34	M10x1_KKB	5	•
	251-21587	BT40H90K16-HTT-L	16	90	50	10	27	34	M12x1_KKB	5	•
	251-21588	BT40H90K18-HTT-L	18	90	50	10	33	42	M12x1_KKB	5	•
	251-21589	BT40H90K20-HTT-L	20	90	52	10	33	42	M16x1_KKB	5	•
	251-21590	BT40H100K25-HTT-L	25	100	58	10	44	53	M16x1_KKB	5	•
	251-21591	BT40H100K32-HTT-L	32	100	62	10	44	53	M16x1_KKB	5	•

SCHRUMPFUTTER MAS BT40 FORM AD/B MANDRINS DE FRETTAGE MAS BT40 TYPE AD/B
 SHRINK FIT CHUCKS MAS BT40 AD/B MANDRINI A CALETTAMENTO MAS BT40 TIPO AD/B
 ТЕРМОЗАЖИМНЫЕ ПАТРОНЫ MAS BT-40 ТИП AD/B 热缩刀柄 MAS BT40 AD/B

MAS BT

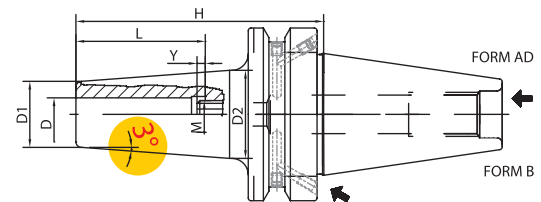
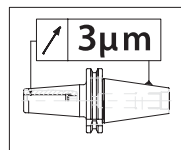

3° PROGRAMME

	Code N.	Description	D	H	L	Ymax	D1	D2	M	SW	G2,5 25000
H90	251-21546	BT40H90K03-HTT	3	90	28	16	9	15	M6	2	•
	251-21547	BT40H90K04-HTT	4	90	28	12	10	16	M6	2	•
	251-21548	BT40H90K05-HTT	5	90	30	10	11	17	M6	2	•
	251-21549	BT40H90K06-HTT	6	90	36	10	12	18	M5	2,5	•
	251-21550	BT40H90K08-HTT	8	90	36	10	14	20	M6	3	•
	251-21551	BT40H90K10-HTT	10	90	41	10	16	22	M8x1	3	•
	251-21552	BT40H90K12-HTT	12	90	47	10	18	24	M10x1	5	•
	251-21553	BT40H90K14-HTT	14	90	47	10	20	26	M10x1	5	•
	251-21554	BT40H90K16-HTT	16	90	50	10	22	28	M12x1	5	•
	251-21555	BT40H90K18-HTT	18	90	50	10	24	30	M12x1	5	•
	251-21556	BT40H90K20-HTT	20	90	52	10	26	32	M16x1	8	•

SCHRUMPFUTTER MAS BT40 FORM AD/B MANDRINS DE FRETTAGE MAS BT40 TYPE AD/B
 SHRINK FIT CHUCKS MAS BT40 AD/B MANDRINI A CALETTAMENTO MAS BT40 TIPO AD/B
 ТЕРМОЗАЖИМНЫЕ ПАТРОНЫ MAS BT-40 ТИП AD/B 热缩刀柄 MAS BT40 AD/B

MAS BT

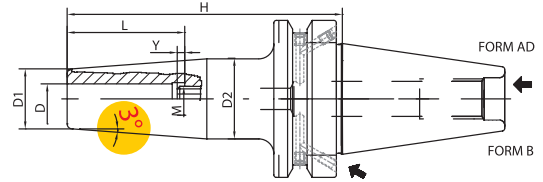
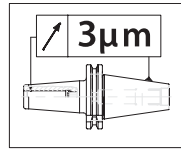

3° PROGRAMME

	Code N.	Description	D	H	L	Y _{max}	D1	D2	M	SW	G2,5 2500
H120	251-21557	BT40H120K03-HTT	3	120	12	-	9	16	-	-	•
	251-21558	BT40H120K04-HTT	4	120	16	-	10	17	-	-	•
	251-21559	BT40H120K05-HTT	5	120	20	-	11	18	-	-	•
	251-21560	BT40H120K06-HTT	6	120	36	10	12	21	M5	2,5	•
	251-21561	BT40H120K08-HTT	8	120	36	10	14	23	M6	3	•
	251-21562	BT40H120K10-HTT	10	120	41	10	16	25	M8x1	3	•
	251-21563	BT40H120K12-HTT	12	120	47	10	18	27	M10x1	5	•
	251-21564	BT40H120K14-HTT	14	120	47	10	20	29	M10x1	5	•
	251-21565	BT40H120K16-HTT	16	120	50	10	22	31	M12x1	5	•
	251-21566	BT40H120K18-HTT	18	120	50	10	24	33	M12x1	5	•
251-21567	BT40H120K20-HTT	20	120	52	10	26	35	M16x1	8	•	
H160	251-21568	BT40H160K03-HTT	3	160	12	-	9	19	-	-	•
	251-21569	BT40H160K04-HTT	4	160	16	-	10	20	-	-	•
	251-21570	BT40H160K05-HTT	5	160	20	-	11	21	-	-	•
	251-21571	BT40H160K06-HTT	6	160	36	10	12	24	M5	2,5	•
	251-21572	BT40H160K08-HTT	8	160	36	10	14	26	M6	3	•
	251-21573	BT40H160K10-HTT	10	160	41	10	16	28	M8x1	3	•
	251-21574	BT40H160K12-HTT	12	160	47	10	18	30	M10x1	5	•
	251-21575	BT40H160K14-HTT	14	160	47	10	20	32	M10x1	5	•
	251-21576	BT40H160K16-HTT	16	160	50	10	22	34	M12x1	5	•
	251-21577	BT40H160K18-HTT	18	160	50	10	24	36	M12x1	5	•
	251-21578	BT40H160K20-HTT	20	160	52	10	26	38	M16x1	8	•

SCHRUMPFUTTER MAS BT50 FORM AD/B MANDRINS DE FRETTAGE MAS BT50 TYPE AD/B
 SHRINK FIT CHUCKS MAS BT50 AD/B MANDRINI A CALETTAMENTO MAS BT50 TIPO AD/B
 ТЕРМОЗАЖИМНЫЕ ПАТРОНЫ MAS BT-50 ТИП АД/В 热缩刀柄 MAS BT50 AD/B

MAS BT AD/B

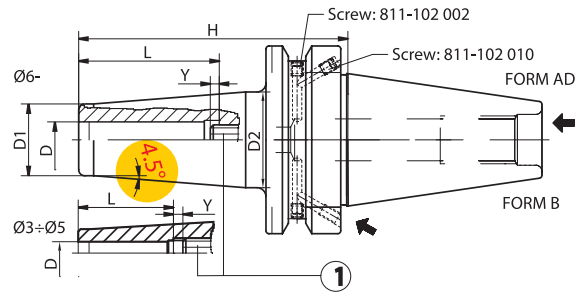
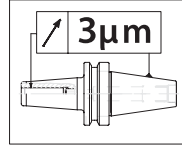

4.5° PROGRAMME

	Code N.	Description	D	H	L	Ymax	D1	D2	G2,5 25000
STANDARD	251-21522	BT50H100K03-HTT	3	100	-	-	10	20	•
	251-21523	BT50H100K04-HTT	4	100	-	-	15	25	•
	251-21524	BT50H100K05-HTT	5	100	-	-	15	25	•
	251-11548	BT50H100K06-HTT	6	100	36	10	21	27	•
	251-11549	BT50H100K08-HTT	8	100	36	10	21	27	•
	251-11550	BT50H100K10-HTT	10	100	41	10	24	32	•
	251-11517	BT50H100K12-HTT	12	100	47	10	24	32	•
	251-11551	BT50H100K14-HTT	14	100	47	10	27	34	•
	251-11552	BT50H100K16-HTT	16	100	50	10	27	42	•
	251-11553	BT50H100K18-HTT	18	100	50	10	33	42	•
	251-11554	BT50H110K20-HTT	20	100	52	10	33	42	•
	251-11555	BT50H110K25-HTT	25	110	58	10	44	53	•
	251-21525	BT50H110K32-HTT	32	110	62	10	44	53	•
H120	251-21526	BT50H120K03-HTT	3	120	-	-	10	20	•
	251-21527	BT50H120K04-HTT	4	120	-	-	15	25	•
	251-21528	BT50H120K05-HTT	5	120	-	-	15	25	•
	251-11556	BT50H120K06-HTT	6	120	36	10	21	27	•
	251-11557	BT50H120K08-HTT	8	120	36	10	21	27	•
	251-11558	BT50H120K10-HTT	10	120	41	10	24	32	•
	251-11559	BT50H120K12-HTT	12	120	47	10	24	32	•
	251-11560	BT50H120K14-HTT	14	120	47	10	27	34	•
	251-11561	BT50H120K16-HTT	16	120	50	10	27	34	•
	251-11562	BT50H120K18-HTT	18	120	50	10	33	42	•
	251-11563	BT50H120K20-HTT	20	120	52	10	33	42	•
	251-21529	BT50H120K25-HTT	25	120	58	10	44	53	•
	251-21530	BT50H120K32-HTT	32	120	62	10	33	53	•
H160	251-21531	BT50H160K03-HTT	3	160	-	-	10	20	•
	251-21532	BT50H160K04-HTT	4	160	-	-	15	25	•
	251-21533	BT50H160K05-HTT	5	160	-	-	15	25	•
	251-21534	BT50H160K06-HTT	6	160	36	10	21	27	•
	251-21535	BT50H160K08-HTT	8	160	36	10	21	27	•
	251-21536	BT50H160K10-HTT	10	160	41	10	24	32	•
	251-21537	BT50H160K12-HTT	12	160	47	10	24	32	•
	251-21538	BT50H160K14-HTT	14	160	47	10	27	34	•
	251-21539	BT50H160K16-HTT	16	160	50	10	27	34	•
	251-21540	BT50H160K18-HTT	18	160	50	10	33	42	•
	251-21541	BT50H160K20-HTT	20	160	52	10	33	42	•
	251-21542	BT50H160K25-HTT	25	160	58	10	44	53	•
	251-21543	BT50H160K32-HTT	32	160	62	10	33	53	•

SCHRUMPFUTTER HSK 63 DIN 69893 FORM A MANDRINS DE FRETTAGE TYPE HSK 63 DIN 69893 A
 SHRINK FIT CHUCKS HSK 63 DIN 69893 TYPE A MANDRINI A CALETTAMENTO HSK 63 DIN 69893 TIPO A
 ТЕРМОЗАЖИМНЫЕ ПАТРОНЫ HSK 63 ПО DIN 69893 ТИП А 热缩刀柄 HSK 63 DIN 69893 A 型

HSK 63A

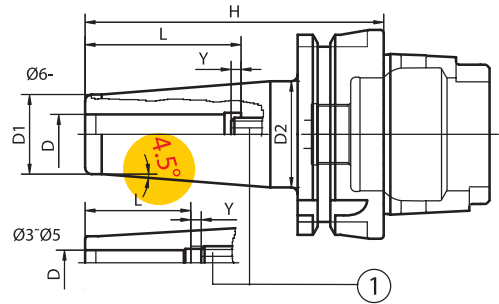
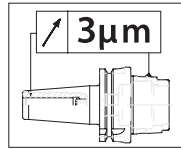

4.5° PROGRAMME

	Code N.	Description	D	H	L	Ymax	D1	D2	G2,5 25000
STANDARD	251-21725	HSK63AH80K03-HTT	3	80	14	10	10	15	•
	251-21726	HSK63AH80K04-HTT	4	80	18	10	15	22	•
	251-21727	HSK63AH80K05-HTT	5	80	22	10	15	22	•
	251-21728	HSK63AH80K06-HTT	6	80	36	10	21	27	•
	251-21729	HSK63AH80K08-HTT	8	80	36	10	21	27	•
	251-21730	HSK63AH85K10-HTT	10	85	42	10	24	32	•
	251-11710	HSK63AH90K12-HTT	12	90	47	10	24	32	•
	251-11711	HSK63AH90K14-HTT	14	90	47	10	27	34	•
	251-11712	HSK63AH95K16-HTT	16	95	50	10	27	34	•
	251-11713	HSK63AH95K18-HTT	18	95	50	10	33	42	•
	251-11714	HSK63AH100K20-HTT	20	100	52	10	33	42	•
	251-21731	HSK63AH115K25-HTT	25	115	58	10	44	53	•
	251-21782	HSK63AH120K32-HTT	32	120	62	10	44	53	•
H120	251-21732	HSK63AH120K03-HTT	3	120	22	10	10	20	•
	251-21733	HSK63AH120K04-HTT	4	120	26	10	15	22	•
	251-21734	HSK63AH120K05-HTT	5	120	30	10	15	22	•
	251-11725	HSK63AH120K06-HTT	6	120	36	10	21	27	•
	251-11726	HSK63AH120K08-HTT	8	120	36	10	21	27	•
	251-11727	HSK63AH120K10-HTT	10	120	41	10	24	32	•
	251-11728	HSK63AH120K12-HTT	12	120	47	10	24	32	•
	251-11729	HSK63AH120K14-HTT	14	120	47	10	27	34	•
	251-11730	HSK63AH120K16-HTT	16	120	50	10	27	34	•
	251-21783	HSK63AH120K18-HTT	18	120	50	10	33	42	•
251-21784	HSK63AH120K20-HTT	20	120	52	10	33	42	•	
251-21785	HSK63AH120K25-HTT	25	120	58	10	44	53	•	
H160	251-21786	HSK63AH160K03-HTT	3	160	22	10	10	20	•
	251-21787	HSK63AH160K04-HTT	4	160	26	10	15	22	•
	251-21788	HSK63AH160K05-HTT	5	160	30	10	15	22	•
	251-21789	HSK63AH160K06-HTT	6	160	36	10	21	27	•
	251-21790	HSK63AH160K08-HTT	8	160	36	10	21	27	•
	251-21791	HSK63AH160K10-HTT	10	160	41	10	24	32	•
	251-21792	HSK63AH160K12-HTT	12	160	47	10	24	32	•
	251-21793	HSK63AH160K14-HTT	14	160	47	10	27	34	•
	251-21794	HSK63AH160K16-HTT	16	160	50	10	27	34	•
	251-21795	HSK63AH160K18-HTT	18	160	50	10	33	42	•
	251-21796	HSK63AH160K20-HTT	20	160	52	10	33	42	•
	251-21797	HSK63AH160K25-HTT	25	160	62	10	44	53	•
	251-21798	HSK63AH160K32-HTT	32	160	62	10	44	53	•

SCHRUMPFUTTER HSK 63 DIN 69893 FORM A MANDRINS DE FRETTAGE TYPE HSK 63 DIN 69893 A
 SHRINK FIT CHUCKS HSK 63 DIN 69893 TYPE A MANDRINI A CALETTAMENTO HSK 63 DIN 69893 TIPO A
 ТЕРМОЗАЖИМНЫЕ ПАТРОНЫ HSK 63 ПО DIN 69893 ТИП А 热缩刀柄 HSK 63 DIN 69893 A 型

DIN 69893A

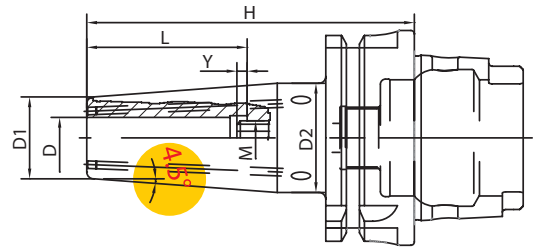
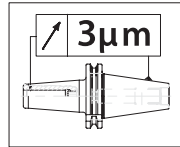

4,5° PROGRAMME WITH RESEALABLE COOLANT DUCT HOLES
4,5° CON PASSAGGIO REFRIGERANTE MEDIANTE CANALI ESTERNI RICHIUDIBILI

	Code N.	Description	D	H	L	Ymax	D1	D2	M	SW	G2,5 25000
STANDARD	251-31760	HSK63AH80K03-HTT-L	3	80	28	16	10	15	M6	2	•
	251-31761	HSK63AH80K04-HTT-L	4	80	28	12	15	22	M6	2	•
	251-31762	HSK63AH80K05-HTT-L	5	80	30	10	15	22	M6	2	•
	251-31763	HSK63AH80K06-HTT-L	6	80	36	10	21	27	M5	2,5	•
	251-31764	HSK63AH80K08-HTT-L	8	80	36	10	21	27	M6	3	•
	251-31765	HSK63AH85K10-HTT-L	10	85	41	10	24	32	M8x1	3	•
	251-31766	HSK63AH90K12-HTT-L	12	90	47	10	24	32	M10x1	5	•
	251-31767	HSK63AH90K14-HTT-L	14	90	47	10	27	34	M10x1	5	•
	251-31768	HSK63AH95K16-HTT-L	16	95	50	10	27	34	M12x1_KKB	5	•
	251-31769	HSK63AH95K18-HTT-L	18	95	50	10	33	42	M12x1_KKB	5	•
	251-31770	HSK63AH100K20-HTT-L	20	100	52	10	33	42	M16x1_KKB	5	•
	251-31771	HSK63AH115K25-HTT-L	25	115	58	10	44	53	M16x1_KKB	5	•
	251-31772	HSK63AH120K32-HTT-L	32	120	62	10	44	53	M16x1_KKB	5	•

SCHRUMPFUTTER HSK 63 DIN 69893 FORM A MANDRINS DE FRETTAGE TYPE HSK 63 DIN 69893 A
 SHRINK FIT CHUCKS HSK 63 DIN 69893 TYPE A MANDRINI A CALETTAMENTO HSK 63 DIN 69893 TIPO A
 ТЕРМОЗАЖИМНЫЕ ПАТРОНЫ HSK 63 ПО DIN 69893 ТИП А 热缩刀柄 HSK 63 DIN 69893 A 型

HSKA1

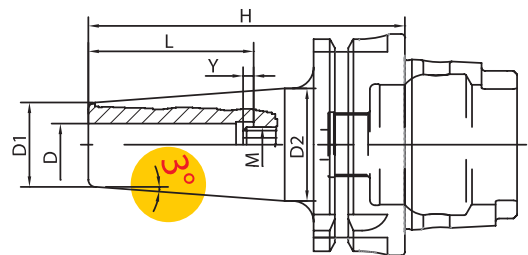
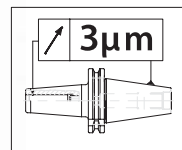

3° PROGRAMME

	Code N.	Description	D	H	L	Ymax	D1	D2	M	SW	G2,5 25000
STANDARD	251-31711	HSK63AH80K03-HTT	3	80	28	16	9	14	M6	2	•
	251-31712	HSK63AH80K04-HTT	4	80	28	12	10	15	M6	2	•
	251-31713	HSK63AH80K05-HTT	5	80	30	10	11	16	M6	2	•
	251-31714	HSK63AH80K06-HTT	6	80	36	10	12	17	M5	2,5	•
	251-31715	HSK63AH80K08-HTT	8	80	36	10	14	19	M6	3	•
	251-31716	HSK63AH85K10-HTT	10	85	41	10	16	21	M8x1	3	•
	251-31717	HSK63AH90K12-HTT	12	90	47	10	18	24	M10x1	5	•
	251-31718	HSK63AH90K14-HTT	14	90	47	10	20	26	M10x1	5	•
	251-31719	HSK63AH95K16-HTT	16	95	50	10	22	28	M12x1	5	•
	251-31720	HSK63AH95K18-HTT	18	95	50	10	24	30	M12x1	5	•
	251-31721	HSK63AH100K20-HTT	20	100	52	10	26	32	M16x1	8	•

SCHRUMPFUTTER HSK 63 DIN 69893 FORM A MANDRINS DE FRETTAGE TYPE HSK 63 DIN 69893 A
 SHRINK FIT CHUCKS HSK 63 DIN 69893 TYPE A MANDRINI A CALETTAMENTO HSK 63 DIN 69893 TIPO A
 ТЕРМОЗАЖИМНЫЕ ПАТРОНЫ HSK 63 ПО DIN 69893 ТИП А 热缩刀柄 HSK 63 DIN 69893 A 型

HSKA2

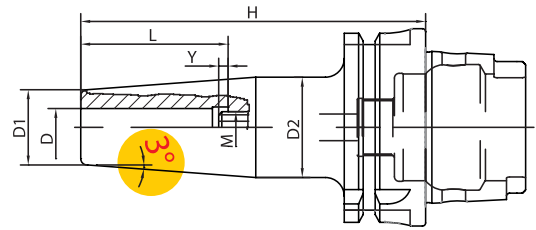
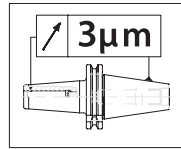

3° PROGRAMME

Code N.	Description	D	H	L	Y _{max}	D1	D2	M	SW	G2,5 2500	
H120	251-31722	HSK63AH120K03-HTT	3	120	12	-	9	16	-	-	•
	251-31723	HSK63AH120K04-HTT	4	120	16	-	10	17	-	-	•
	251-31724	HSK63AH120K05-HTT	5	120	20	-	11	18	-	-	•
	251-31725	HSK63AH120K06-HTT	6	120	36	10	12	21	M5	2,5	•
	251-31726	HSK63AH120K08-HTT	8	120	36	10	14	23	M6	3	•
	251-31727	HSK63AH120K10-HTT	10	120	41	10	16	25	M8x1	3	•
	251-31728	HSK63AH120K12-HTT	12	120	47	10	18	27	M10x1	5	•
	251-31729	HSK63AH120K14-HTT	14	120	47	10	20	29	M10x1	5	•
	251-31730	HSK63AH120K16-HTT	16	120	50	10	22	31	M12x1	5	•
	251-31731	HSK63AH120K18-HTT	18	120	50	10	24	33	M12x1	5	•
251-31732	HSK63AH120K20-HTT	20	120	52	10	26	35	M16x1	8	•	
H160	251-31733	HSK63AH160K03-HTT	3	160	12	-	9	19	-	-	•
	251-31734	HSK63AH160K04-HTT	4	160	16	-	10	20	-	-	•
	251-31735	HSK63AH160K05-HTT	5	160	20	-	11	21	-	-	•
	251-31736	HSK63AH160K06-HTT	6	160	36	10	12	24	M5	2,5	•
	251-31737	HSK63AH160K08-HTT	8	160	36	10	14	26	M6	3	•
	251-31738	HSK63AH160K10-HTT	10	160	41	10	16	28	M8x1	3	•
	251-31739	HSK63AH160K12-HTT	12	160	47	10	18	30	M10x1	5	•
	251-31740	HSK63AH160K14-HTT	14	160	47	10	20	32	M10x1	5	•
	251-31741	HSK63AH160K16-HTT	16	160	50	10	22	34	M12x1	5	•
	251-31742	HSK63AH160K18-HTT	18	160	50	10	24	36	M12x1	5	•
	251-31743	HSK63AH160K20-HTT	20	160	52	10	26	38	M16x1	8	•

SCHRUMPFUTTER HSK 100 DIN 69893 FORM A MANDRINS DE FRETTAGE TYPE HSK 100 DIN 69893 A
 SHRINK FIT CHUCKS HSK 100 DIN 69893 TYPE MANDRINI A CALETTAMENTO HSK 100 DIN 69893 TIPO A
 АТЕРМОЗАЖИМНЫЕ ПАТРОНЫ HSK 100 ПО DIN 69893 ТИП А 热缩刀柄 HSK 100 DIN 69893 A 型

HSK 100A

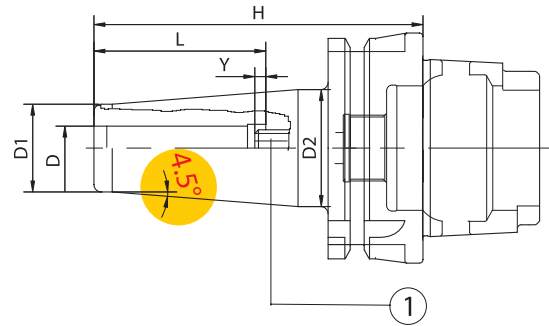
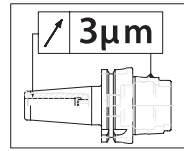

4.5° PROGRAMME

	Code N.	Description	D	H	L	Y _{max}	D1	D2	G2,5 25000
STANDARD	251-21735	HSK100AH85K06-HTT	6	85	36	10	21	27	•
	251-21736	HSK100AH85K08-HTT	8	85	36	10	21	27	•
	251-21737	HSK100AH90K10-HTT	10	90	41	10	24	32	•
	251-21738	HSK100AH95K12-HTT	12	95	47	10	24	32	•
	251-21739	HSK100AH95K14-HTT	14	95	47	10	27	34	•
	251-21740	HSK100AH100K16-HTT	16	100	50	10	27	34	•
	251-21741	HSK100AH100K18-HTT	18	100	50	10	33	42	•
	251-21742	HSK100AH105K20-HTT	20	105	52	10	33	42	•
	251-21743	HSK100AH115K25-HTT	25	115	58	10	44	53	•
	251-21799	HSK100AH120K32-HTT	32	120	62	10	44	53	•
EXTENDED	251-21744	HSK100AH120K06-HTT	6	120	36	10	21	27	•
	251-21745	HSK100AH120K08-HTT	8	120	36	10	21	27	•
	251-21746	HSK100AH120K10-HTT	10	120	41	10	24	32	•
	251-21747	HSK100AH120K12-HTT	12	120	47	10	24	32	•
	251-21748	HSK100AH120K14-HTT	14	120	47	10	27	34	•
	251-21749	HSK100AH120K16-HTT	16	120	50	10	27	34	•
	251-21750	HSK100AH120K18-HTT	18	120	50	10	33	42	•
	251-21751	HSK100AH120K20-HTT	20	120	52	10	33	42	•
	251-31701	HSK100AH160K25-HTT	25	160	58	10	44	53	•
	251-31702	HSK100AH160K32-HTT	32	160	62	10	44	53	•

SCHRUMPFUTTER HSK 100 DIN 69893 FORM A MANDRINS DE FRETTAGE TYPE HSK 100 DIN 69893 A
 SHRINK FIT CHUCKS HSK 100 DIN 69893 TYPE MANDRINI A CALETTAMENTO HSK 100 DIN 69893 TIPO A
 АТЕРМОЗАЖИМНЫЕ ПАТРОНЫ HSK 100 ПО DIN 69893 ТИП А 热缩刀柄 HSK 100 DIN 69893 A 型

HSKA1

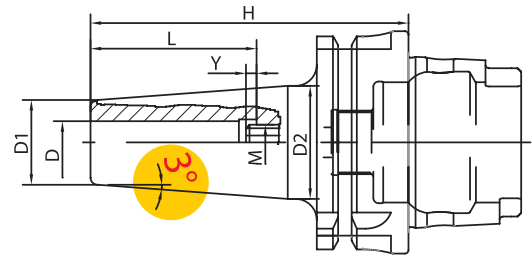
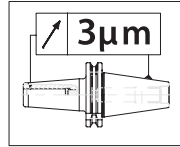

3° PROGRAMME

	Code N.	Description	D	H	L	Y _{max}	D1	D2	M	SW	G2,5 2500
STANDARD	251-31744	HSK100AH85K06-HTT	6	85	36	10	12	17	M5	2,5	•
	251-31745	HSK100AH85K08-HTT	8	85	36	10	14	19	M6	3	•
	251-31746	HSK100AH90K10-HTT	10	90	41	10	16	21	M8x1	3	•
	251-31747	HSK100AH95K12-HTT	12	95	47	10	18	24	M10x1	5	•
	251-31748	HSK100AH95K14-HTT	14	95	47	10	20	26	M10x1	5	•
	251-31749	HSK100AH100K16-HTT	16	100	50	10	22	28	M12x1	5	•
	251-31750	HSK100AH100K18-HTT	18	100	50	10	24	30	M12x1	5	•
	251-31751	HSK100AH105K20-HTT	20	105	52	10	27	34	M16x1	8	•

SCHRUMPFUTTER HSK 100 DIN 69893 FORM A MANDRINS DE FRETTAGE TYPE HSK 100 DIN 69893 A
 SHRINK FIT CHUCKS HSK 100 DIN 69893 TYPE MANDRINI A CALETTAMENTO HSK 100 DIN 69893 TIPO A
 АТЕРМОЗАЖИМНЫЕ ПАТРОНЫ HSK 100 ПО DIN 69893 ТИП А 热缩刀柄 HSK 100 DIN 69893 A 型

HSKA2

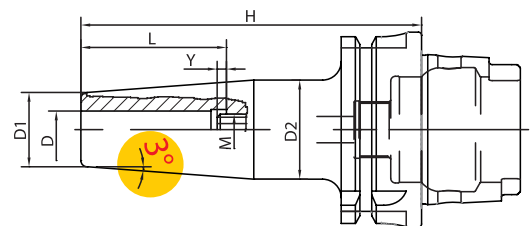
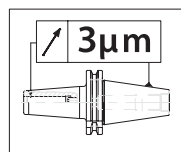

3° PROGRAMME

	Code N.	Description	D	H	L	Y _{max}	D1	D2	M	SW	G2,5 2500
H120	251-31752	HSK100AH120K06-HTT	6	120	36	10	12	20	M5	2,5	•
	251-31753	HSK100AH120K08-HTT	8	120	36	10	14	22	M6	3	•
	251-31754	HSK100AH120K10-HTT	10	120	41	10	16	24	M8x1	3	•
	251-31755	HSK100AH120K12-HTT	12	120	47	10	18	26	M10x1	5	•
	251-31756	HSK100AH120K14-HTT	14	120	47	10	20	28	M10x1	5	•
	251-31757	HSK100AH120K16-HTT	16	120	50	10	22	30	M12x1	5	•
	251-31758	HSK100AH120K18-HTT	18	120	50	10	24	32	M12x1	5	•
	251-31759	HSK100AH120K20-HTT	20	120	52	10	27	35	M16x1	8	•

SCHRUMPFUTTER HSK 40 DIN 69893 FORM E MANDRINS DE FRETTAGE TYPE HSK 40 DIN 69893 E
 SHRINK FIT CHUCKS HSK 40 DIN 69893 TYPE E MANDRINI A CALETTAMENTO HSK 40 DIN 69893 TIPO E
 ТЕРМОЗАЖИМНЫЕ ПАТРОНЫ HSK 40 ПО DIN 69893 ТИП E 热缩刀柄 HSK 40 DIN 69893 E 型

HSK 40E

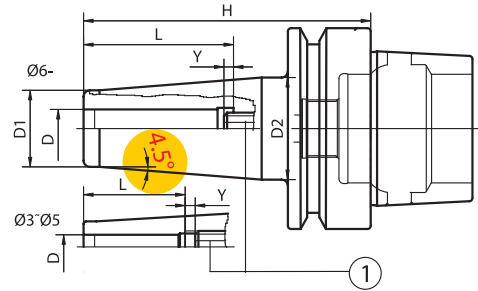
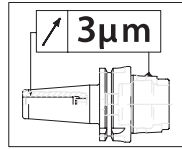

4.5° PROGRAMME

Code N.	Description	D	H	L	Y _{max}	D1	D2	G2,5 25000
251-17374	HSK40EH60K03-HTT	3	60	22	10	10	16	•
251-17375	HSK40EH60K04-HTT	4	60	26	10	10	16	•
251-17376	HSK40EH60K05-HTT	5	60	30	10	10	16	•
251-17333	HSK40EH80K06-HTT	6	80	36	10	21	27	•
251-17334	HSK40EH80K08-HTT	8	80	36	10	21	27	•
251-17335	HSK40EH80K10-HTT	10	80	41	10	24	32	•
251-27322	HSK40EH90K12-HTT	12	90	47	10	24	32	•
251-17378	HSK40EH90K14-HTT	14	90	47	10	27	34	•
251-27323	HSK40EH90K16-HTT	16	90	50	10	27	34	•

STANDARD

SCHRUMPFUTTER HSK 50 DIN 69893 FORM E MANDRINS DE FRETTAGE TYPE HSK 50 DIN 69893 E
 SHRINK FIT CHUCKS HSK 50 DIN 69893 TYPE E MANDRINI A CALETTAMENTO HSK 50 DIN 69893 TIPO E
 ТЕРМОЗАЖИМНЫЕ ПАТРОНЫ HSK 50 ПО DIN 69893 ТИП E 热缩刀柄 HSK 50 DIN 69893 E 型

HSK 50E

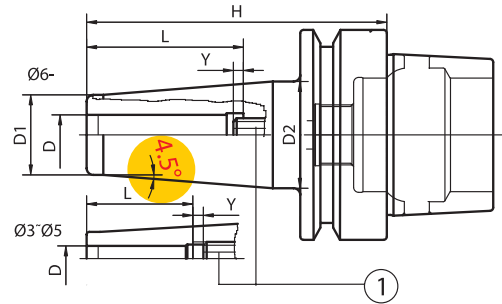
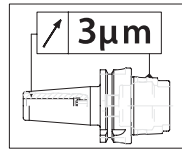

4.5° PROGRAMME

Code N.	Description	D	H	L	Ymax	D1	D2	G2,5 25000
251-27324	HSK50EH80K03-HTT	3	80	22	10	10	18	•
251-27325	HSK50EH80K04-HTT	4	80	26	10	15	18	•
251-27326	HSK50EH80K05-HTT	5	80	30	10	15	20	•
251-27327	HSK50EH80K06-HTT	6	80	36	10	21	27	•
251-27328	HSK50EH80K08-HTT	8	80	36	10	21	27	•
251-27329	HSK50EH85K10-HTT	10	85	41	10	24	36	•
251-17304	HSK50EH90K12-HTT	12	90	47	10	24	32	•
251-17305	HSK50EH90K14-HTT	14	90	47	10	27	34	•
251-17306	HSK50EH95K16-HTT	16	95	50	10	27	34	•
251-17315	HSK50EH95K18-HTT	18	95	50	10	33	42	•
251-17316	HSK50EH100K20-HTT	20	100	52	10	33	42	•

SCHRUMPFUTTER HSK 63 DIN 69893 FORM E MANDRINS DE FRETTAGE TYPE HSK 63 DIN 69893 E
 SHRINK FIT CHUCKS HSK 63 DIN 69893 TYPE E MANDRINI A CALETTAMENTO HSK 63 DIN 69893 TIPO E
 ТЕРМОЗАЖИМНЫЕ ПАТРОНЫ HSK 63 ПО DIN 69893 ТИП E 热缩刀柄 HSK 63 DIN 69893 E 型

HSK 63E

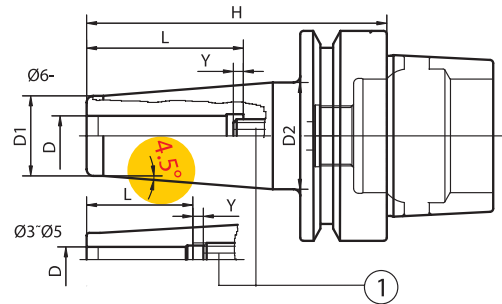
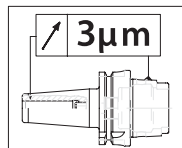

4.5° PROGRAMME

Code N.	Description	D	H	L	Ymax	D1	D2	G2,5 25000
251-27333	HSK63EH80K03-HTT	3	80	22	10	10	15	•
251-27334	HSK63EH80K04-HTT	4	80	26	10	15	22	•
251-27335	HSK63EH80K05-HTT	5	80	30	10	15	22	•
251-27336	HSK63EH80K06-HTT	6	80	36	10	21	27	•
251-27337	HSK63EH80K08-HTT	8	80	36	10	21	27	•
251-27338	HSK63EH85K10-HTT	10	85	41	10	24	32	•
251-17310	HSK63EH90K12-HTT	12	90	47	10	24	32	•
251-17311	HSK63EH90K14-HTT	14	90	47	10	27	34	•
251-17312	HSK63EH95K16-HTT	16	95	50	10	27	34	•
251-17313	HSK63EH95K18-HTT	18	95	50	10	33	42	•
251-17314	HSK63EH100K20-HTT	20	100	52	10	33	42	•
251-27339	HSK63EH115K25-HTT	25	115	58	10	44	53	•
251-27356	HSK63EH115K32-HTT	32	120	62	10	44	53	•

SCHRUMPFUTTER HSK 100 DIN 69893 FORM A MANDRINS DE FRETTAGE TYPE HSK 100 DIN 69893 A
 SHRINK FIT CHUCKS HSK 100 DIN69893 TYPE MANDRINI A CALETTAMENTO HSK 100 DIN 69893 TIPO A
 АТЕРМОЗАЖИМНЫЕ ПАТРОНЫ HSK 100 ПО DIN 69893 ТИП А 热缩刀柄 HSK 100 DIN 69893 A 型

HSKE

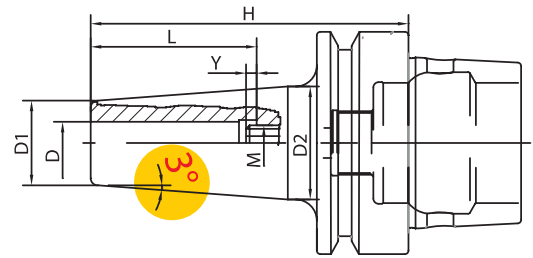
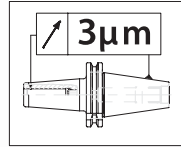
**3° PROGRAMME**

	Code N.	Description	D	H	L	Y _{max}	D1	D2	M	SW	G2,5 25000
STANDARD	251-27361	HSK40EH60K03-HTT	3	60	28	16	9	13	M6	2	•
	251-27362	HSK40EH60K04-HTT	4	60	28	12	10	14	M6	2	•
	251-27363	HSK40EH60K05-HTT	5	60	30	10	11	15	M6	2	•
	251-27364	HSK40EH80K06-HTT	6	80	36	10	12	18	M5	2,5	•
	251-27365	HSK40EH80K08-HTT	8	80	36	10	14	20	M5	3	•
	251-27366	HSK40EH80K10-HTT	10	80	41	10	16	22	M5	3	•
	251-27367	HSK40EH80K12-HTT	12	80	47	10	18	24	M5	2,5	•

SCHRUMPFUTTER HSK 50 DIN 69893 FORM E MANDRINS DE FRETTAGE TYPE HSK 50 DIN 69893 E
 SHRINK FIT CHUCKS HSK 50 DIN69893 TYPE E MANDRINI A CALETTAMENTO HSK 50 DIN 69893 TIPO E
 ТЕРМОЗАЖИМНЫЕ ПАТРОНЫ HSK 50 ПО DIN 69893 ТИП E 热缩刀柄 HSK 50 DIN 69893 E 型

HSKE

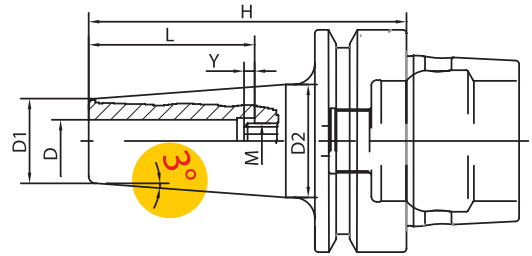
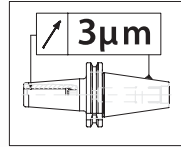

3° PROGRAMME

Code N.	Description	D	H	L	Y _{max}	D1	D2	M	SW	G2,5 25000
H80	251-27368	3	80	28	16	9	15	M6	2	•
	251-27369	4	80	28	12	10	16	M6	2	•
	251-27370	5	80	30	10	11	17	M6	2	•
	251-27371	6	80	36	10	12	18	M5	2,5	•
	251-27372	8	80	36	10	14	20	M6	3	•
	251-27373	10	80	41	10	16	22	M5	2,5	•
	251-27374	12	80	47	10	18	24	M5	2,5	•

SCHRUMPFUTTER HSK 50 DIN 69893 FORM E MANDRINS DE FRETTAGE TYPE HSK 50 DIN 69893 E
 SHRINK FIT CHUCKS HSK 50 DIN69893 TYPE E MANDRINI A CALETTAMENTO HSK 50 DIN 69893 TIPO E
 ТЕРМОЗАЖИМНЫЕ ПАТРОНЫ HSK 50 ПО DIN 69893 ТИП E 热缩刀柄 HSK 50 DIN 69893 E 型

HSKE

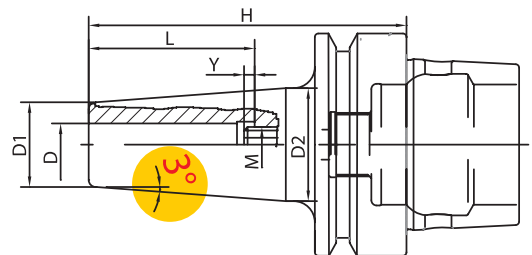
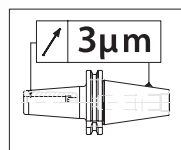

3° PROGRAMME

Code N.	Description	D	H	L	Y _{max}	D1	D2	M	SW	G2,5 25000
H80	251-27375	6	80	36	10	12	18	M5	2,5	•
	251-27376	8	80	36	10	14	20	M6	3	•
	251-27377	10	80	41	10	16	22	M5	2,5	•
	251-27378	12	80	47	10	18	24	M5	2,5	•

SCHRUMPFVERLÄNGERUNGEN RALLONGES DE FRETAGE
SHRINKING EXTENSIONS PROLUNGHE PER CALETTAMENTO
ТЕРМОЗАЖИМНЫЕ УДЛИНИТЕЛИ 热缩延长杆

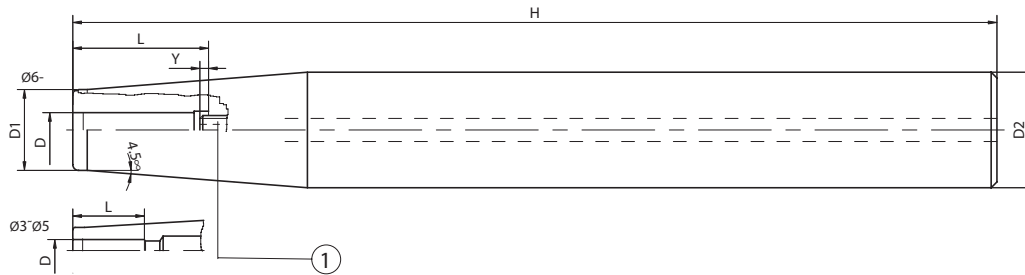

Code N.	Description	D	H	L	Ymax	D1	D2
251-15110	D12H150K03-HTT	3	150	-	-	8	12
251-15111	D12H150K04-HTT	4	150	-	-	8	12
251-15133	D12H150K05-HTT	5	150	-	-	10	12
251-15134	D12H150K06-HTT	6	150	36	10	10	12
251-15112	D16H150K03-HTT	3	150	-	-	10	16
251-15113	D16H150K04-HTT	4	150	-	-	10	16
251-15114	D16H150K05-HTT	5	150	-	-	10	16
251-15115	D16H150K06-HTT	6	150	36	10	10	16
251-15139	D16H150K08-HTT	8	150	36	10	12	16
251-15140	D20H150K03-HTT	3	150	-	-	10	20
251-15141	D20H150K04-HTT	4	150	-	-	10	20
251-15116	D20H150K05-HTT	5	150	-	-	10	20
251-15117	D20H150K06-HTT	6	150	36	10	10	20
251-15118	D20H150K08-HTT	8	150	36	10	12	20
251-15145	D20H150K10-HTT	10	150	42	10	14	20
251-15146	D20H150K12-HTT	12	150	47	10	16	20
251-15147	D25H150K03-HTT	3	150	-	-	10	25
251-15148	D25H150K04-HTT	4	150	-	-	10	25
251-15149	D25H150K05-HTT	5	150	-	-	15	25
251-15150	D25H150K06-HTT	6	150	36	10	20	25
251-15119	D25H150K08-HTT	8	150	36	10	20	25
251-15120	D25H150K10-HTT	10	150	42	10	20	25
251-15121	D25H150K12-HTT	12	150	47	10	20	25
251-15122	D25H150K14-HTT	14	150	47	10	20	25
251-15123	D25H150K16-HTT	16	150	50	10	22	25
251-15156	D32H150K06-HTT	6	150	36	10	20	32
251-15157	D32H150K08-HTT	8	150	36	10	20	32
251-15124	D32H150K10-HTT	10	150	42	10	24	32
251-15125	D32H150K12-HTT	12	150	47	10	24	32
251-15126	D32H150K14-HTT	14	150	47	10	27	32
251-15127	D32H150K16-HTT	16	150	50	10	27	32
251-15162	D32H150K18-HTT	18	150	50	10	27	32
251-15128	D32H150K20-HTT	20	150	52	10	27	32